



DRAFT

CITY LIGHTS™

SICIS

 dalTile®
IMAGINE WHAT'S POSSIBLE™

TABLE OF CONTENTS

AVIAX MANHATTAN	4
WHEEL ST. MORITZ.....	6
INCENSIO BANGKOK	12
CHROMO LONDON	16
DELICA MONTE CARLO	20
MIX V BARCELONA.....	22
COMBINATION ST. MORITZ	28
CARINA LONDON	30
517 MANHATTAN	31
INDIRAMA BARCELONA	34
DORADO PARIS	35
HERRINGBONE LONDON.....	38
TALISMAN LONDON	39
INDIRA SOUTH BEACH	42
DUNE CAPRI.....	46
FLEXUS SOUTH BEACH	58
RANDOM HOLLYWOOD	60
CHANTILLY PARIS	64
TARANTULA LAS VEGAS	66
TECHNICAL INFORMATION	78

Cover photo:

Aviax

Manhattan

KEY COLORS: 535 · 564 · 746

CL38445145

SICIS

CITY LIGHTS™

St. Moritz CL65*



page 8

South Beach CL71*

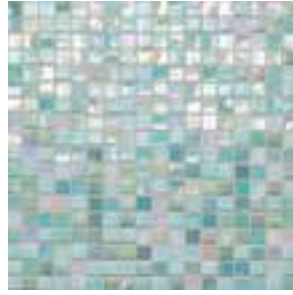

page 40

Honolulu CL72**

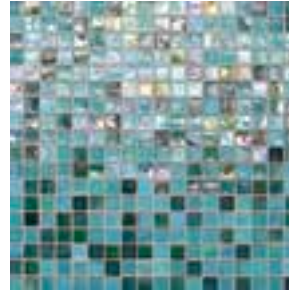

page 50

Monte Carlo CL63**



page 24

Paris CL67*



page 36

St. Thomas CL70**

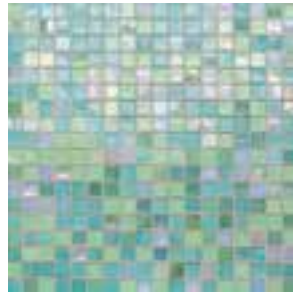

page 54

Rio CL73**



page 76

Bangkok CL61**



page 14

Hollywood CL64*



page 62

Fiji CL75*



page 74

Las Vegas CL69**

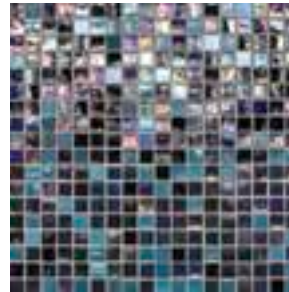

page 68

Manhattan CL74**



page 32

Barcelona CL66**



page 26

Capri CL68**

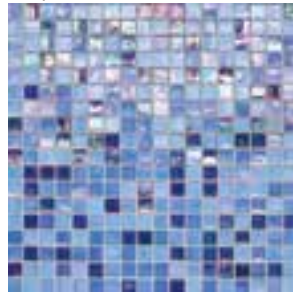

page 44

Tokyo CL62*



page 72

London CL60**

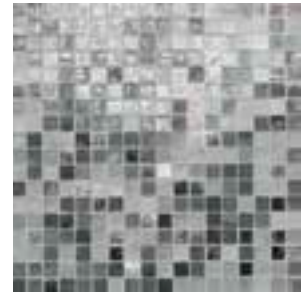

page 18

*Paper-mounted **Mesh-mounted



BARRELS 564



BARRELS 535



DOMES 564



BARRELS 535



BARRELS 746

SICIS

Aviax Manhattan**

CL38445145

KEY COLORS: 535 · 564 · 746

**Mesh-mounted

The item can be used in wet or humid areas.
The adhesive and the grouting must be epoxy mortar.
All the technical specifications are contained in the
Installation Manual on our website and at your disposal.

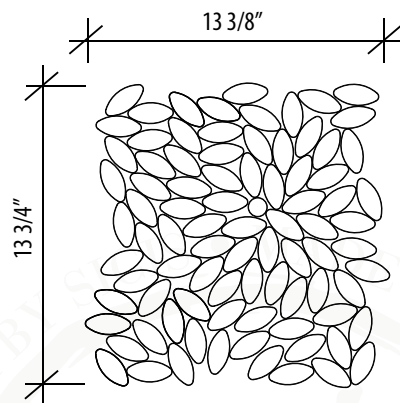

Aviax Manhattan - Sheet "A"

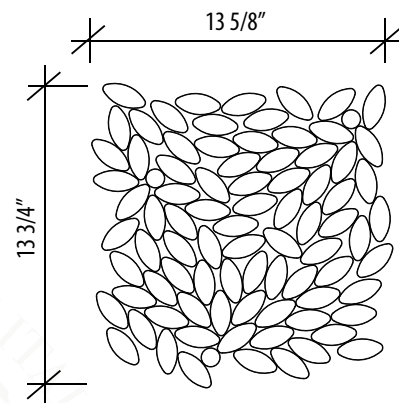

Aviax Manhattan - Sheet "B"

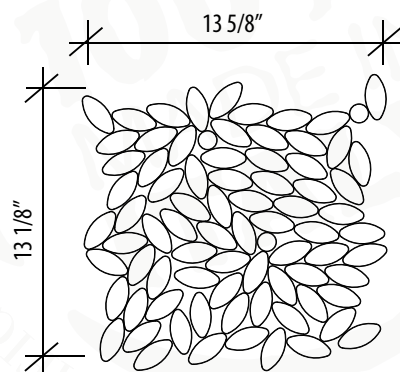

Aviax Manhattan - Sheet "C"

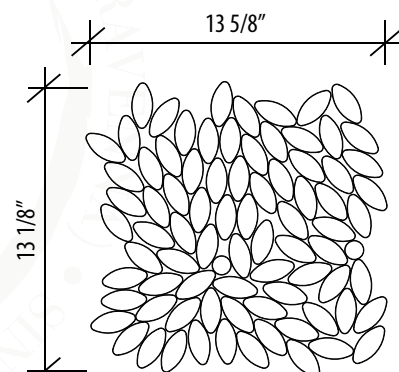

Aviax Manhattan - Sheet "D"

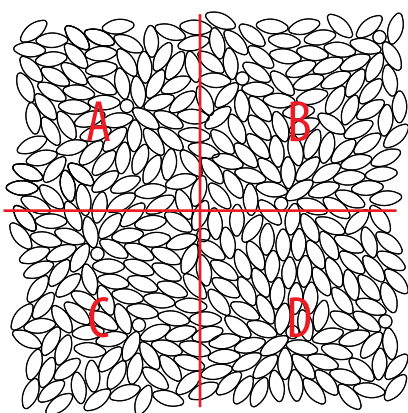

Aviax Manhattan
Full Module - Layout

Module Size	SF per Module	UOM	U/M per Carton	Module per Carton
25" x 24 3/4"	3,8	SF	15,2	4

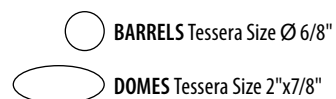

Item can be purchased by full module

 **daltile**
IMAGINE WHAT'S POSSIBLE™

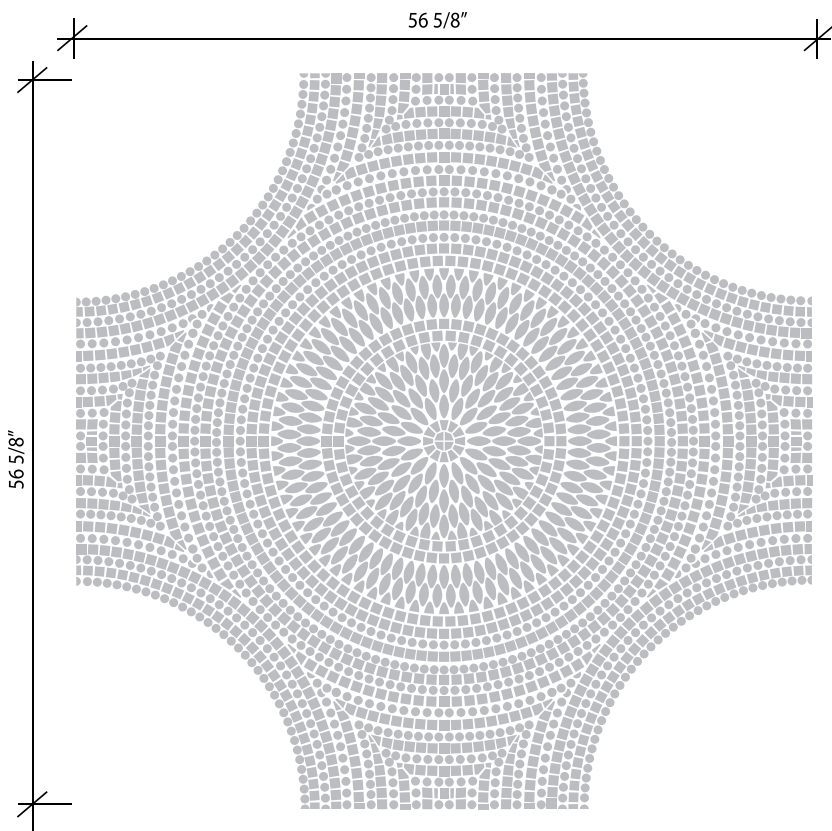

Wheel St. Moritz - Module "A"

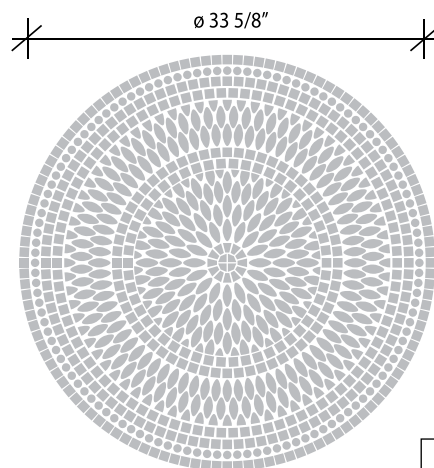

Wheel St. Moritz - Module "B"

 CUBES Tessera Size 7/8"x7/8"

 BARRELS Tessera Size Ø 6/8"

 DOMES Tessera Size 2"x7/8"

Module "A" Size	SF per Piece	UOM	U/M per Crate	Pieces per Crate
56 5/8" x 56 5/8"	16,09	SF	from 16,09 to 193,08	from 1 to 12

Item can be purchased by full module

Module "B" Size	SF per Piece	UOM	U/M per Crate	Pieces per Crate
Ø 33 5/8"	6,16	SF	from 6,16 to 73,92	from 1 to 12

Item can be purchased by full module



SICIS

CITY LIGHTS™



Wheel St. Moritz**

CL55445157

KEY COLORS: 720

**Mesh-mounted



BARRELS 720



CUBES 720



BARRELS 720

In dry environment can be used cementitious adhesive and grouting mortar.
The item can be used in wet or humid areas.
The adhesive and the grouting must be epoxy mortar.
All the technical specifications are contained in the Installation Manual on our website and at your disposal.

 **daltile**[®]
IMAGINE WHAT'S POSSIBLE™

BLEND



St. Moritz CL65*

Composition:

Ginger	33%
Daisy	33%
Lilium	34%

***Paper-mounted**

In dry environment can be used cementitious adhesive and grouting mortar.

The item can be used in wet or humid areas.

The adhesive and the grouting must be epoxy mortar.

All the technical specifications are contained in the Installation Manual on our website and at your disposal.

FIELD COLOR



Ginger · Glimmer

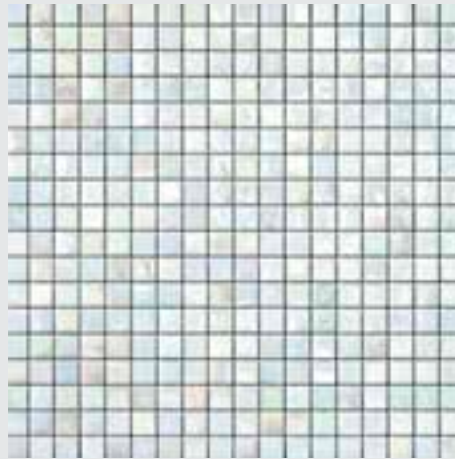

Daisy · Iridium

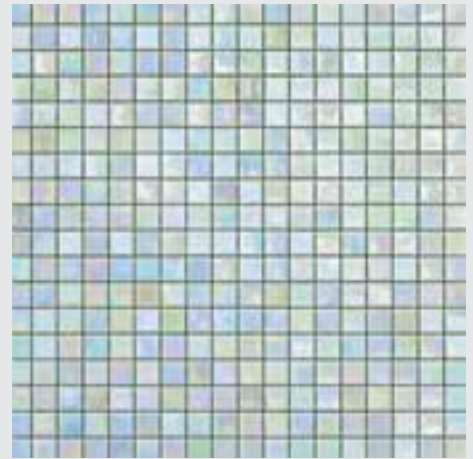

Lilium · Iridium

Chip size
0 ⁵/₈" x 0 ⁵/₈"

Sheet size
11 ⁵/₈" x 11 ⁵/₈"

Thickness
1/8"

ITEM CAN BE PURCHASED BY THE SHEET

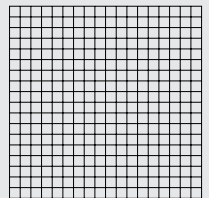

GLASS MOSAIC

CITY LIGHTS™

 **daltile**
IMAGINE WHAT'S POSSIBLE™



ST. MORITZ CL65

SICIS



GLASS MOSAIC
CITY LIGHTS™

 daltile
IMAGINE WHAT'S POSSIBLE™



SICIS

Incensio Bangkok*

CL85445164

KEY COLORS: 510,5 G · 501 · 532 · 538 · 570

***Paper-mounted**

 **BARRELS** Tessera Size \varnothing 6/8"

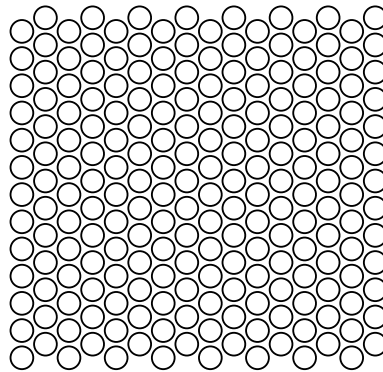

Sheet size

11^{5/8"} x 10^{7/8"}

Thickness

1/4"

Box

16 sheets

ITEM CAN BE PURCHASED BY THE SHEET



BARRELS 510,5 G



BARRELS 501



BARRELS 532



BARRELS 570



BARRELS 538

The item can be used in wet or humid areas.
The adhesive and the grouting must be epoxy mortar.
All the technical specifications are contained in the
Installation Manual on our website and at your disposal.

 **daltile**[®]
IMAGINE WHAT'S POSSIBLE™

BLEND



Bangkok CL61**

Composition:

Wenge	60%
Chestnut 4	30%
Sandalwood	10%

****Mesh-mounted**

In dry environment can be used cementitious adhesive and grouting mortar.

The item can be used in wet or humid areas.

The adhesive and the grouting must be epoxy mortar.

All the technical specifications are contained in the Installation Manual on our website and at your disposal.

FIELD COLOR

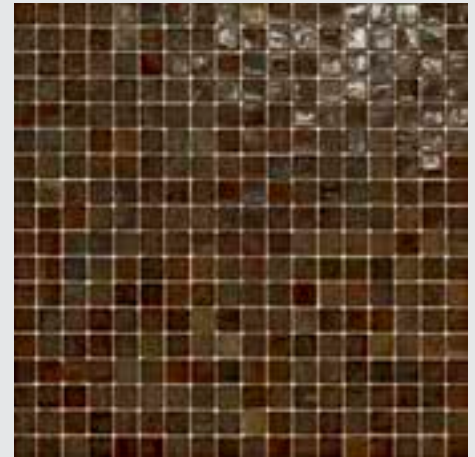

Wenge · Natural

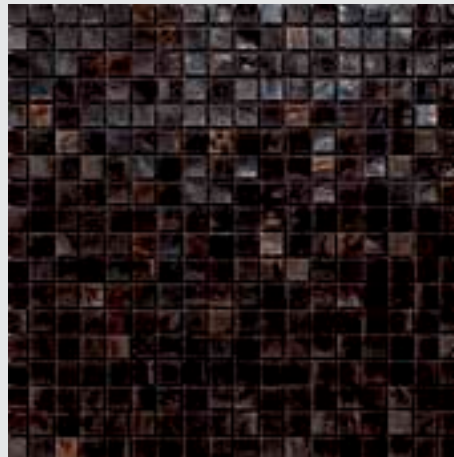

Chestnut 4 · Murano



Sandalwood · Natural

Chip size
 $0 \frac{5}{8}'' \times 0 \frac{5}{8}''$

Sheet size
 $11 \frac{5}{8}'' \times 11 \frac{5}{8}''$

Thickness
 $1/8''$

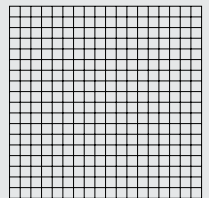

ITEM CAN BE PURCHASED BY THE SHEET

GLASS MOSAIC

CITY LIGHTS™

 **daltile**
 IMAGINE WHAT'S POSSIBLE™

Chromo London*

CL83445162

KEY COLORS: 521 A · 521 S · 545 S

***Paper-mounted**



BARRELS 521 A



BARRELS 521 S



BARRELS 545 S

BARRELS Tessera Size \varnothing 6/8" 

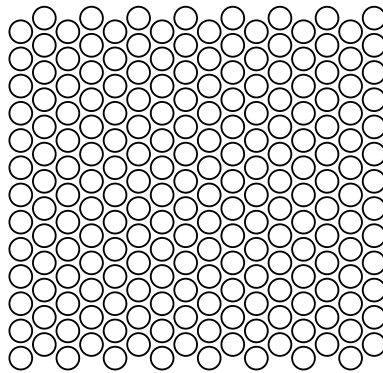

Sheet size

11^{5/8}" x 10^{7/8}"

Thickness

1/4"

Box

16 sheets

ITEM CAN BE PURCHASED BY THE SHEET



SICIS

The item can be used in wet or humid areas.
The adhesive and the grouting must be epoxy mortar.
All the technical specifications are contained in the
Installation Manual on our website and at your disposal.



BLEND



London CL60**

Composition:

Mud 50%

Slate 40%

Vis One 10%

****Mesh-mounted**

The item can be used in wet or humid areas.
The adhesive and the grouting must be epoxy mortar.
All the technical specifications are contained in the
Installation Manual on our website and at your disposal.

SICIS

FIELD COLOR

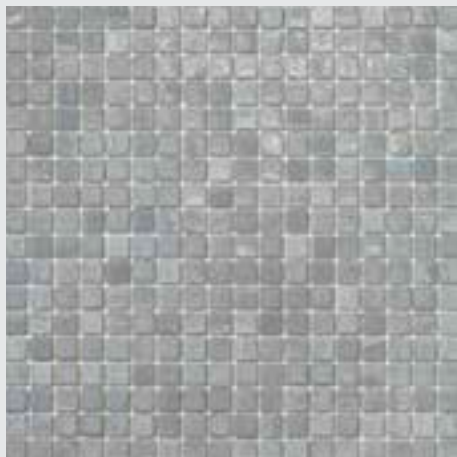

Slate · Natural

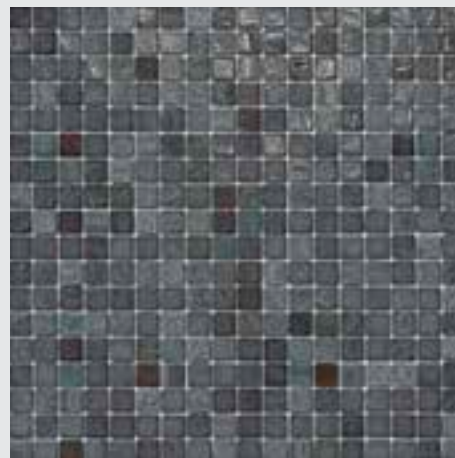

Mud · Natural



Vis One · Colibri

Chip size
0 ⁵/₈" x 0 ⁵/₈"

Sheet size
11 ⁵/₈" x 11 ⁵/₈"

Thickness
1/8"

ITEM CAN BE PURCHASED BY THE SHEET

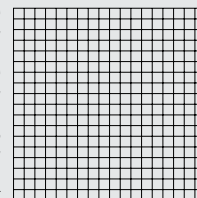

GLASS MOSAIC

CITY LIGHTS™

 **daltile**[®]
IMAGINE WHAT'S POSSIBLE™



BARRELS 510,5 R



BARRELS 528



BARRELS 515



BARRELS NG MILK CHOCOLATE



PETITES FLEURS F05



DOMES 510,5 R



DOMES 528



DOMES EMPERADOR LIGHT

SICIS

Delicia Monte Carlo**

CL37445144

KEY COLORS: 510,5 R · 515 · 528 · F05 · NG Milk Chocolate · Emperador Light

****Mesh-mounted**

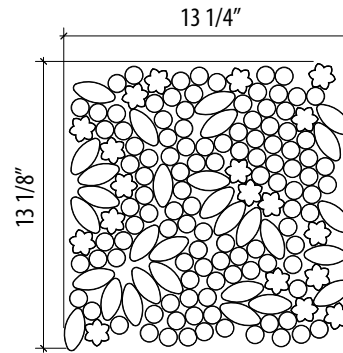

Delicia Montecarlo - Sheet "A"

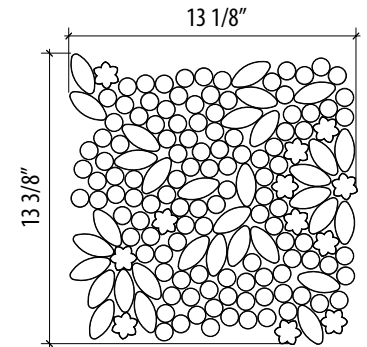

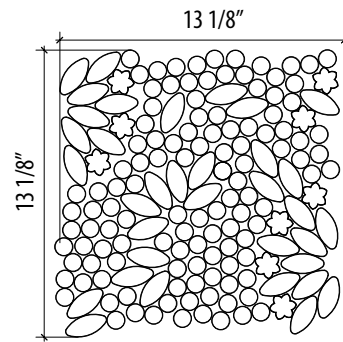

Delicia Montecarlo - Sheet "B"

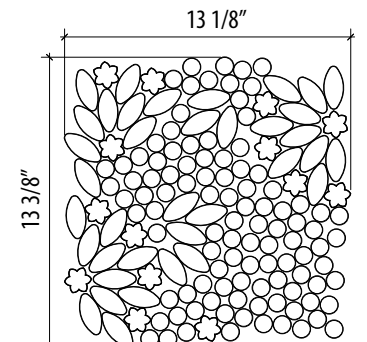

Delicia Montecarlo - Sheet "C"



Delicia Montecarlo - Sheet "D"

-  BARRELS Tessera Size \varnothing 6/8"
-  PETITES FLEURS Tessera Size \varnothing 1 1/4"
-  DOMES Tessera Size 2"x7/8"

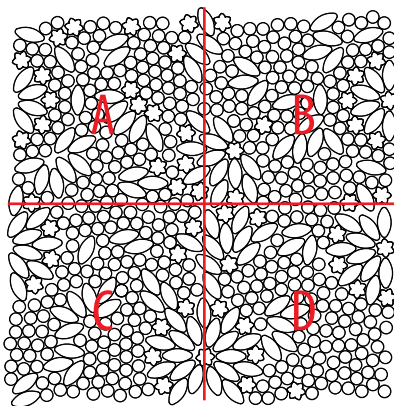

Delicia Montecarlo
Full Module - Layout

Module Size	SF per Module	UOM	U/M per Carton	Module per Carton
24" x 24"	4,278	SF	17,112	4

Item can be purchased by full module

The item can be used in wet or humid areas.
The adhesive and the grouting must be epoxy mortar.
All the technical specifications are contained in the
Installation Manual on our website and at your disposal.

 **daltile**
IMAGINE WHAT'S POSSIBLE™

Mix V Barcelona**

CL44445151

KEY COLORS:

554 · 522 · NG Sand
Calacatta Vagli
Emperador Light

****Mesh-mounted**



Calacatta Vagli



Emperador Light

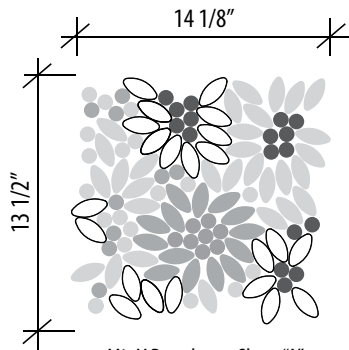

Mix V Barcelona - Sheet "A"

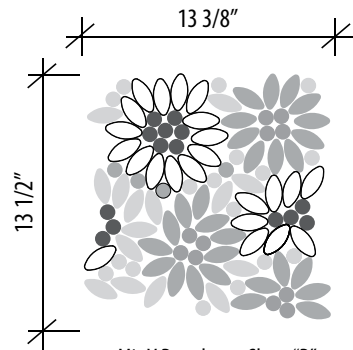

Mix V Barcelona - Sheet "B"

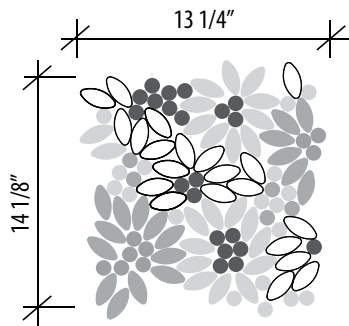

Mix V Barcelona - Sheet "C"

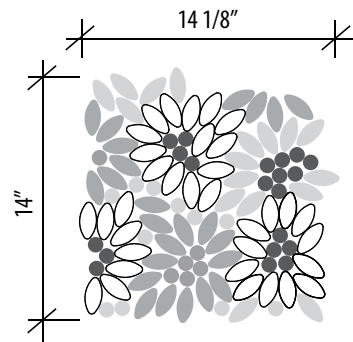

Mix V Barcelona - Sheet "D"

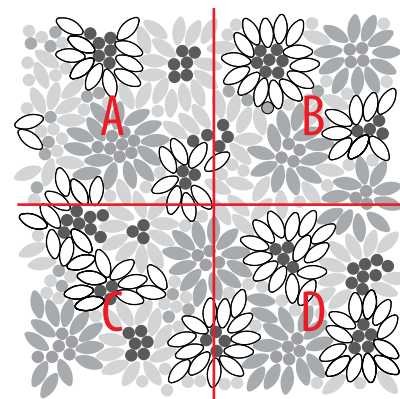

Mix V Barcelona
Full Module - Layout

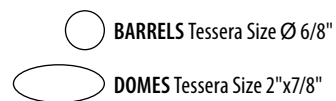

○ BARRELS Tessera Size Ø 6/8"

◌ DOMES Tessera Size 2"x7/8"

Module Size	SF per Module	UOM	U/M per Carton	Module per Carton
26 1/2" x 25 3/4"	4,16	SF	16,64	4

Item can be purchased by full module

SICIS

Mix V
**Barcelona
CL44445151



BARRELS 554



BARRELS 522



BARRELS NG SAND



BARRELS MARBLE CALACATTA



DOMES 554



DOMES NG SAND



DOMES MARBLE CALACATTA



BLEND



Monte Carlo CL63**

Composition:

Wenge	48%
Chestnut 4	37%
Mirtillo	12%
Vis Two	03%

****Mesh-mounted**

The item can be used in wet or humid areas.
The adhesive and the grouting must be epoxy mortar.
All the technical specifications are contained in the
Installation Manual on our website and at your disposal.

SICIS

FIELD COLOR

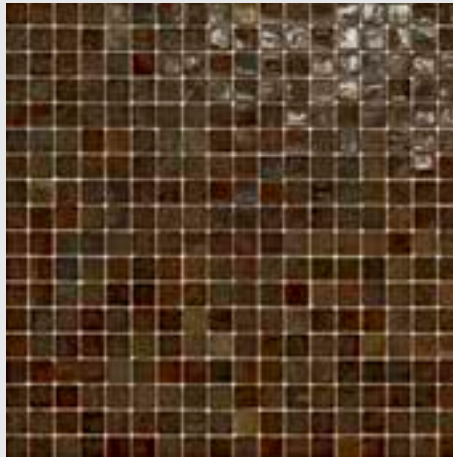

Wenge · Natural

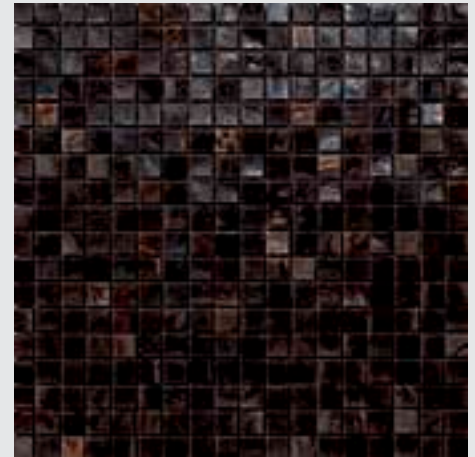

Chestnut 4 · Murano

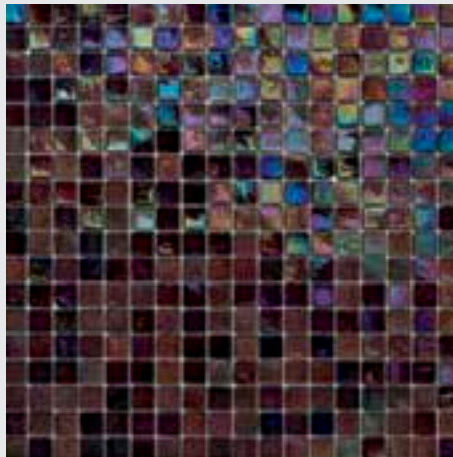

Mirtillo · Glimmer



Vis Two · Colibri

Chip size
0 5/8" x 0 5/8"

Sheet size
11 5/8" x 11 5/8"

Thickness
1/8"

ITEM CAN BE PURCHASED BY THE SHEET

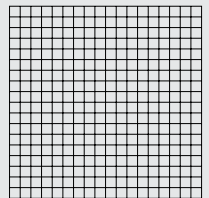

GLASS MOSAIC

CITY LIGHTS™

 **daltile**
IMAGINE WHAT'S POSSIBLE™

BLEND



Barcelona CL66**

Composition:

Cinnamon	57%
Engeril	07%
Marigold 3	29%
Sand	07%

****Mesh-mounted**

The item can be used in wet or humid areas.
The adhesive and the grouting must be epoxy mortar.
All the technical specifications are contained in the
Installation Manual on our website and at your disposal.

SICIS

FIELD COLOR

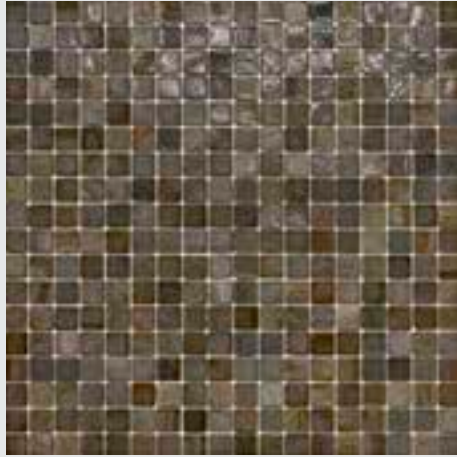

Cinnamon · Natural

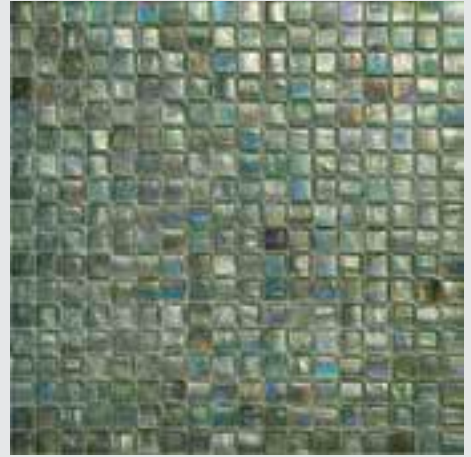

Engeril · Colibrí



Marigold 3 · Iridium



Sand · Natural

Chip size

0 ⁵/₈" x 0 ⁵/₈"

Sheet size

11 ⁵/₈" x 11 ⁵/₈"

Thickness

1/8"

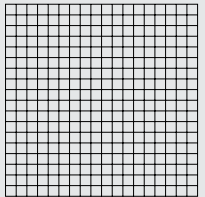

ITEM CAN BE PURCHASED BY THE SHEET

GLASS MOSAIC

CITY LIGHTS™

 **daltile**[®]
IMAGINE WHAT'S POSSIBLE™



SICIS

Combination St. Moritz**

(FIELD) CL46445153

(BORDER) CL47445154

(CORNER) CL48445155

KEY COLORS: 220 · 221 · F01

****Mesh-mounted**

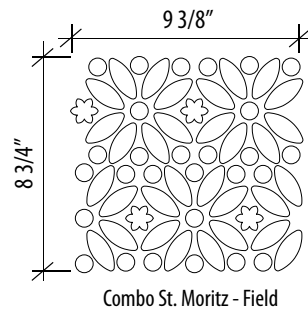
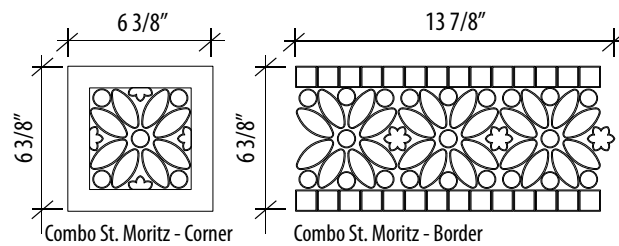

 **BARRELS** Tessera Size Ø 6/8"

 **PETITES FLEURS** Tessera Size Ø 1 1/4"

 **DOMES** Tessera Size 2" x 7/8"

Sheet Size	SF per Piece	UOM	U/M per Carton	Pieces per Carton
6 3/8" x 6 3/8"	0,277	SF	_____	_____

Corner - Item can be purchased by the sheet

Sheet Size	SF per Piece	UOM	U/M per Carton	Pieces per Carton
13 7/8" x 6 3/8"	0,582	SF	_____	_____

Border - Item can be purchased by the sheet

Sheet Size	SF per Piece	UOM	U/M per Carton	Pieces per Carton
9 3/8" x 8 3/4"	0,531	SF	8,496	16

Field - Item can be purchased by the sheet



BARRELS 220



BARRELS 221



PETITES FLEURS F01



PETITES FLEURS F16



DOMES 220



DOMES 221

In dry environment can be used cementitious adhesive and grouting mortar.
The item can be used in wet or humid areas.
The adhesive and the grouting must be epoxy mortar.
All the technical specifications are contained in the Installation Manual on our website and at your disposal.

 **daltile**
IMAGINE WHAT'S POSSIBLE™



BARRELS 521 S



BARRELS 502



BARRELS 524



BARRELS 521 A



BARRELS 535



BARRELS 550



BARRELS NG WHITE



BARRELS SLATE



BARRELS 746



BARRELS MARBLE
CALACATTA



BARRELS MARBLE
BARDIGLIO
ORIENTALE

Carina London*

CL58445160

KEY COLORS:

502 · 521 A · 521 S · 524 · 535 · 550 · 746 · NG Slate · NG White

***Paper-mounted**

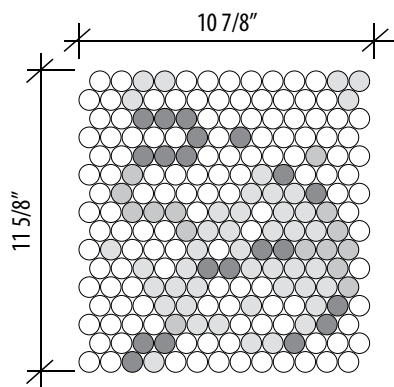

Carina London - Sheet "A"

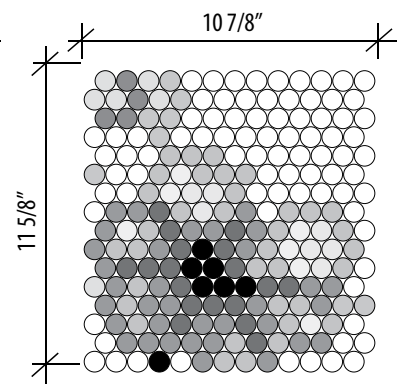

Carina London - Sheet "B"

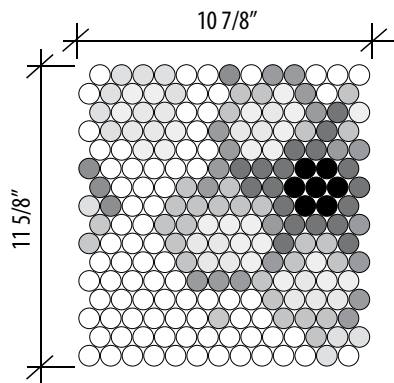

Carina London - Sheet "C"

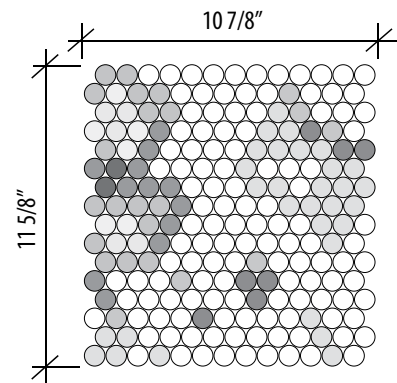

Carina London - Sheet "D"

Sheet A	Sheet B
Sheet C	Sheet D

Carina London
Full Module - Layout

○ BARRELS Tessera Size Ø 6/8"

The item can be used in wet or humid areas.
The adhesive and the grouting must be epoxy
mortar. All the technical specifications are
contained in the Installation Manual on our
website and at your disposal.

Sheet Size	SF per Module	UOM	U/M per Carton	Module per Carton
10 7/8" x 11 5/8"	3,48	SF	13,92	4

Item can be purchased by full module

SICIS

517 Manhattan*

CL57445159

KEY COLORS: 220 · 521 S · 550 · 720

***Paper-mounted**

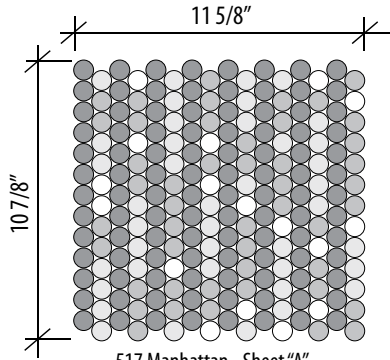

517 Manhattan - Sheet "A"

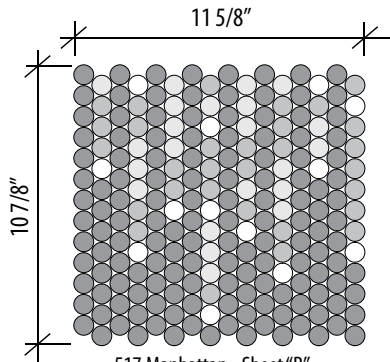

517 Manhattan - Sheet "B"

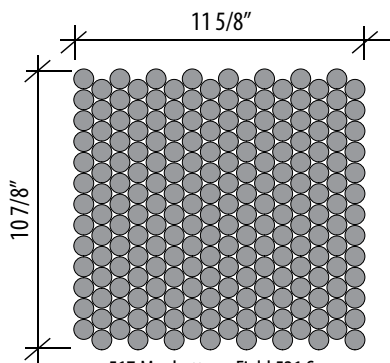

517 Manhattan - Field 521 S



BARRELS 521 S



BARRELS 550



BARRELS 220



BARRELS 720

A —

B —

C —

○ BARRELS Tessera Size Ø 6/8"

Sheet Size	SF per Piece	UOM	U/M per Carton	Pieces per Carton
10 7/8" x 11 5/8"	0,87	SF	13,92	16

Item can be purchased by the sheet



The item can be used in wet or humid areas. The adhesive and the grouting must be epoxy mortar. All the technical specifications are contained in the Installation Manual on our website and at your disposal.

daltile
IMAGINE WHAT'S POSSIBLE™

BLEND



Manhattan CL74**

Composition:

Black	30%
Titanium 3	25%
Mud	25%
Vis One	10%
Grey Flannel	05%
Rastaban	05%

****Mesh-mounted**

The item can be used in wet or humid areas.
The adhesive and the grouting must be epoxy mortar.
All the technical specifications are contained in the
Installation Manual on our website and at your disposal.

FIELD COLOR

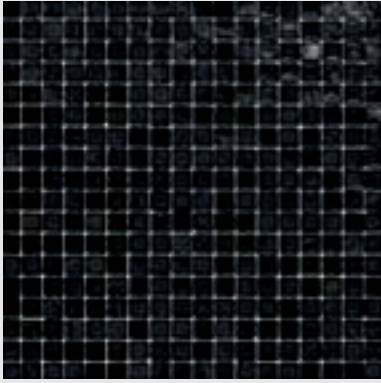

Black · Murano

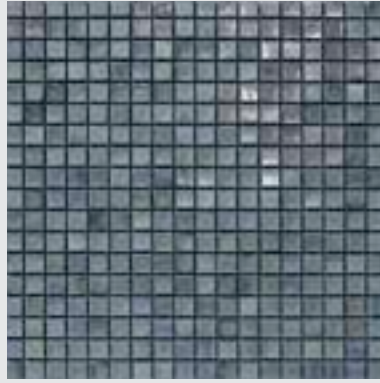

Titanium 3 · Murano

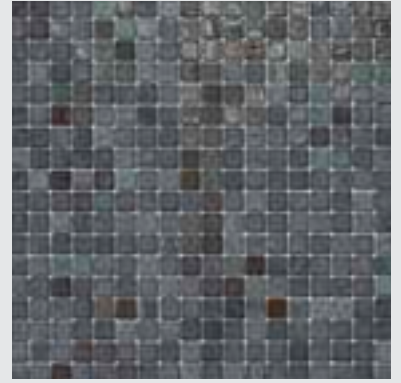

Mud · Natural

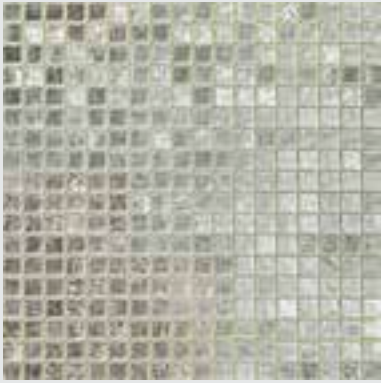

Vis One · Colibri

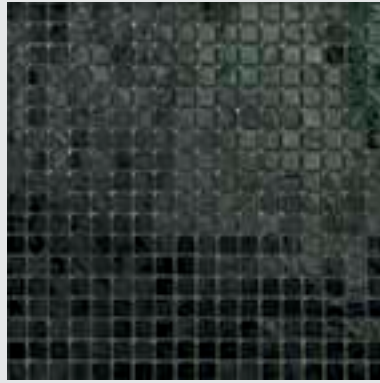

Grey Flannel · Colibri



Rastaban · Colibri

GLASS MOSAIC

CITY LIGHTS™

Chip size
0 5/8" x 0 5/8"

Sheet size
11 5/8" x 11 5/8"

Thickness
1/8"

ITEM CAN BE PURCHASED BY THE SHEET

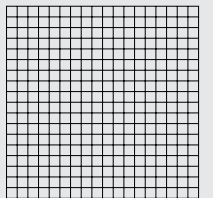

daltile
IMAGINE WHAT'S POSSIBLE™

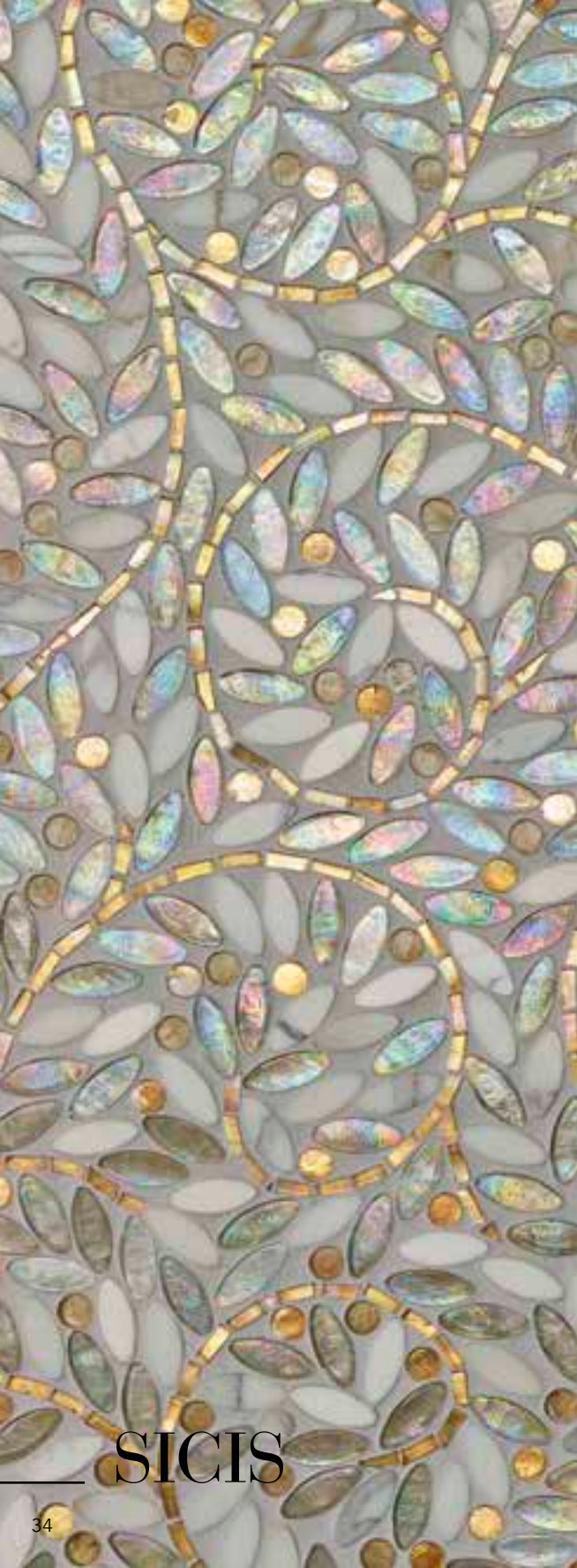

BARRELS AURUM



DOMES 555



DOMES 524



CUBES AURUM



BARRELS 527

Indirama Barcelona**

CL39445146

KEY COLORS: 524 · 527 · 555 · Aurum · Calacatta Vagli

****Mesh-mounted**

The item can be used in wet or humid areas.
The adhesive and the grouting must be epoxy mortar.
All the technical specifications are contained in the
Installation Manual on our website and at your disposal.

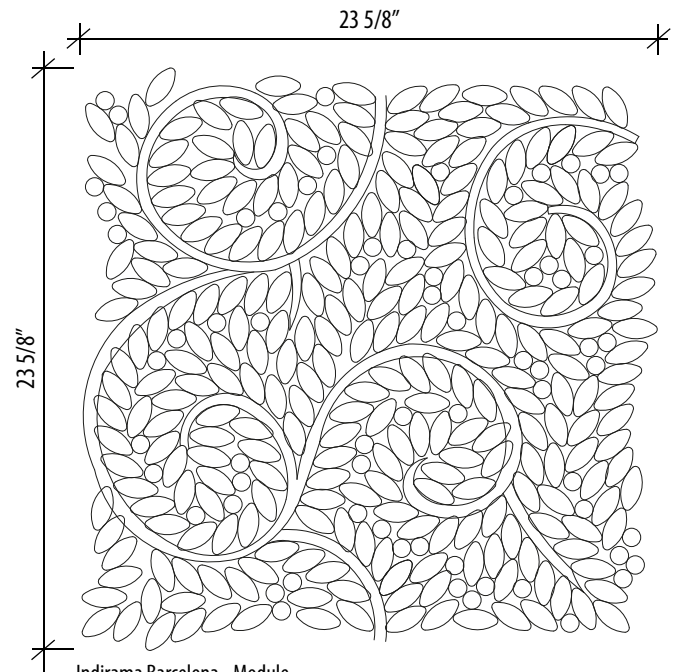

○ BARRELS Tessera Size Ø 6/8"

□ CUBES Tessera Size 7/8"x7/8"

◌ DOMES Tessera Size 2"x7/8"

Sheet Size	SF per Piece	UOM	U/M per Carton	Pieces per Carton
23 5/8" x 23 5/8"	3,875	SF	3,875	1

Item can be purchased by full module

SICIS



The item can be used in wet or humid areas.
 The adhesive and the grouting must be epoxy mortar.
 All the technical specifications are contained in the
 Installation Manual on our website and at your disposal.



Dorado Paris**

CL45445152

KEY COLORS: 510,5 G · Aurum · F04 · NG Birch · NG Sand

****Mesh-mounted**

Sheet "A"	Sheet "B"	Sheet "C"
-----------	-----------	-----------

Full Module
Layout

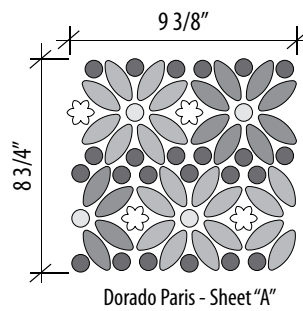

Dorado Paris - Sheet "A"

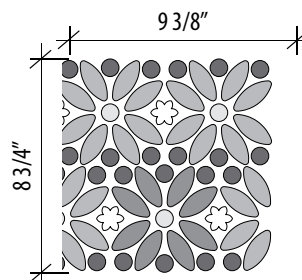

Dorado Paris - Sheet "B"

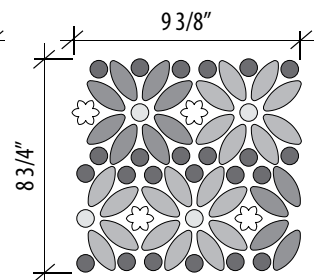

Dorado Paris - Sheet "C"

Sheet Size	SF per Piece	UOM	U/M per Carton	Pieces per Carton
9 3/8" x 8 3/4"	0,531	SF	8,496	16

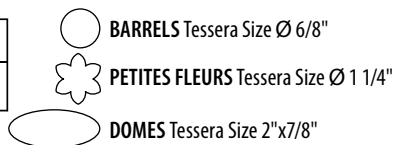

Item can be purchased by full module

daltile
 IMAGINE WHAT'S POSSIBLE™

BLEND



Paris CL67*

Composition:

Sand	55%
Marigold 3	25%
Birch	10%
Zinnia 2	10%

***Paper-mounted**

In dry environment can be used cementitious adhesive and grouting mortar.

The item can be used in wet or humid areas.

The adhesive and the grouting must be epoxy mortar.

All the technical specifications are contained in the Installation Manual on our website and at your disposal.

FIELD COLOR



Sand · Natural



Marigold 3 · Iridium



Birch · Natural



Zinnia 2 · Iridium

Chip size
0 5/8" x 0 5/8"

Sheet size
11 5/8" x 11 5/8"

Thickness
1/8"

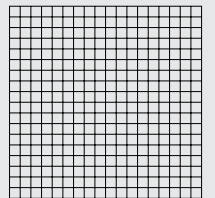

ITEM CAN BE PURCHASED BY THE SHEET

GLASS MOSAIC

CITY LIGHTS™

 **daltile**
IMAGINE WHAT'S POSSIBLE™



DOMES NG SLATE



DOMES 521 A



DOMES 521 S



DOMES 545 S

Herringbone London**

CL56445158

KEY COLORS:

521 A · 521 S · 545 S · NG Slate

****Mesh-mounted**

The item can be used in wet or humid areas.
The adhesive and the grouting must be epoxy mortar.
All the technical specifications are contained in the
Installation Manual on our website and at your disposal.

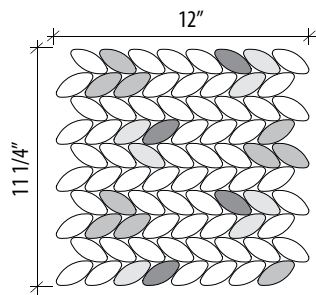

Herringbone London - Sheet "A"

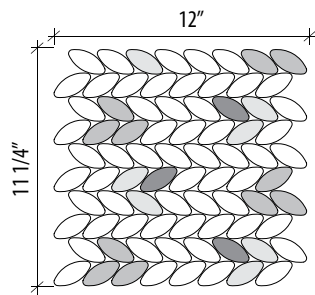

Herringbone London - Sheet "B"

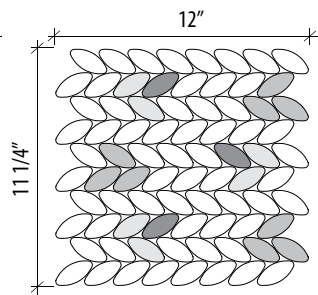

Herringbone London - Sheet "C"

Sheet Size	SF per Module	UOM	U/M per Carton	Module per Carton
12" x 11 1/4"	2,556	SF	12,78	5

 DOMES Tessera Size 2"x7/8"

Item can be purchased by the sheet

SICIS

Talisman London**

CL40445147

KEY COLORS: 502 · 521 A · 550 · 562 · F06 · Bardiglio Orientale

****Mesh-mounted**

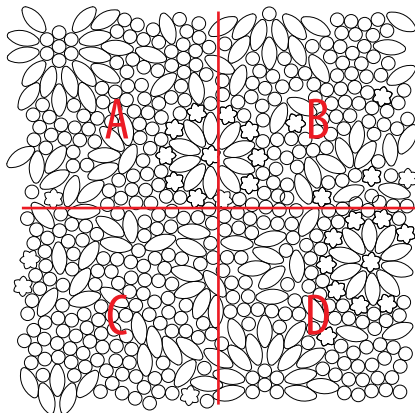
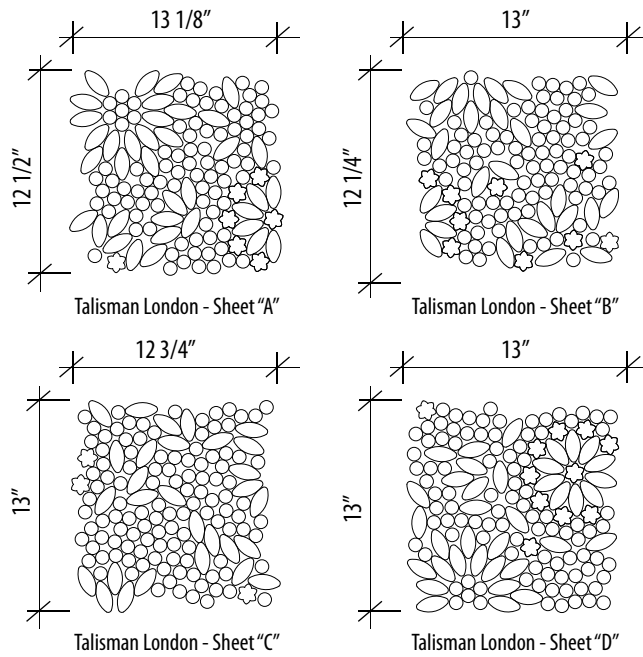

 **BARRELS** Tessera Size \varnothing 6/8"

 **PETITES FLEURS** Tessera Size \varnothing 1 1/4"

 **DOMES** Tessera Size 2"x7/8"

Module Size	SF per Module	UOM	U/M per Carton	Module per Carton
25 1/8" x 24 7/8"	3,882	SF	15,528	4

Item can be purchased by full module



BARRELS 521 A



BARRELS 562



BARRELS 502



BARRELS 550



PETITES FLEURS F06



**BARRELS MARBLE
BARDIGLIO ORIENTALE**



DOMES 521 A



DOMES 562



DOMES 502



**DOMES MARBLE
BARDIGLIO ORIENTALE**

The item can be used in wet or humid areas.
The adhesive and the grouting
must be epoxy mortar.
All the technical specifications are contained
in the Installation Manual
on our website and at your disposal.

BLEND



South Beach CL71*

Composition:

Petunia 1	20%
Hyacinth	30%
Ananas	30%
Breeze	20%

***Paper-mounted**

In dry environment can be used cementitious adhesive and grouting mortar.

The item can be used in wet or humid areas.

The adhesive and the grouting must be epoxy mortar.

All the technical specifications are contained in the Installation Manual on our website and at your disposal.

FIELD COLOR

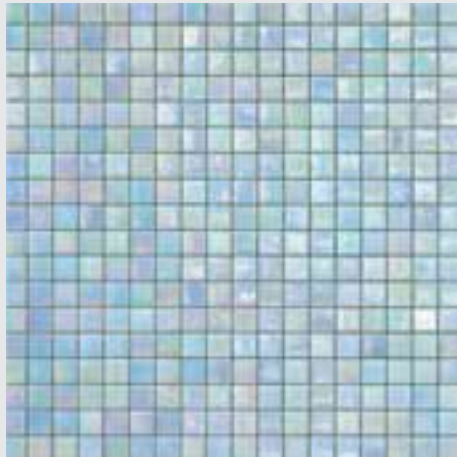

Petunia 1 · Iridium



Hyacinth · Iridium



Ananas · Glimmer



Breeze · WaterGlass

Chip size
0 5/8" x 0 5/8"

Sheet size
11 5/8" x 11 5/8"

Thickness
1/8"

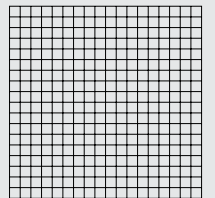

ITEM CAN BE PURCHASED BY THE SHEET

GLASS MOSAIC

CITY LIGHTS™

 **daltile**
IMAGINE WHAT'S POSSIBLE™



BARRELS 220



BARRELS 550



BARRELS 557



CUBES 720



DOMES 720



DOMES 557



DOMES 550

SICIS

The item can be used in wet or humid areas.
The adhesive and the grouting must be epoxy mortar.
All the technical specifications are contained
in the Installation Manual
on our website and at your disposal.

Indira South Beach**

CL43445150

KEY COLORS:

220, 550, 557, 720

****Mesh-mounted**

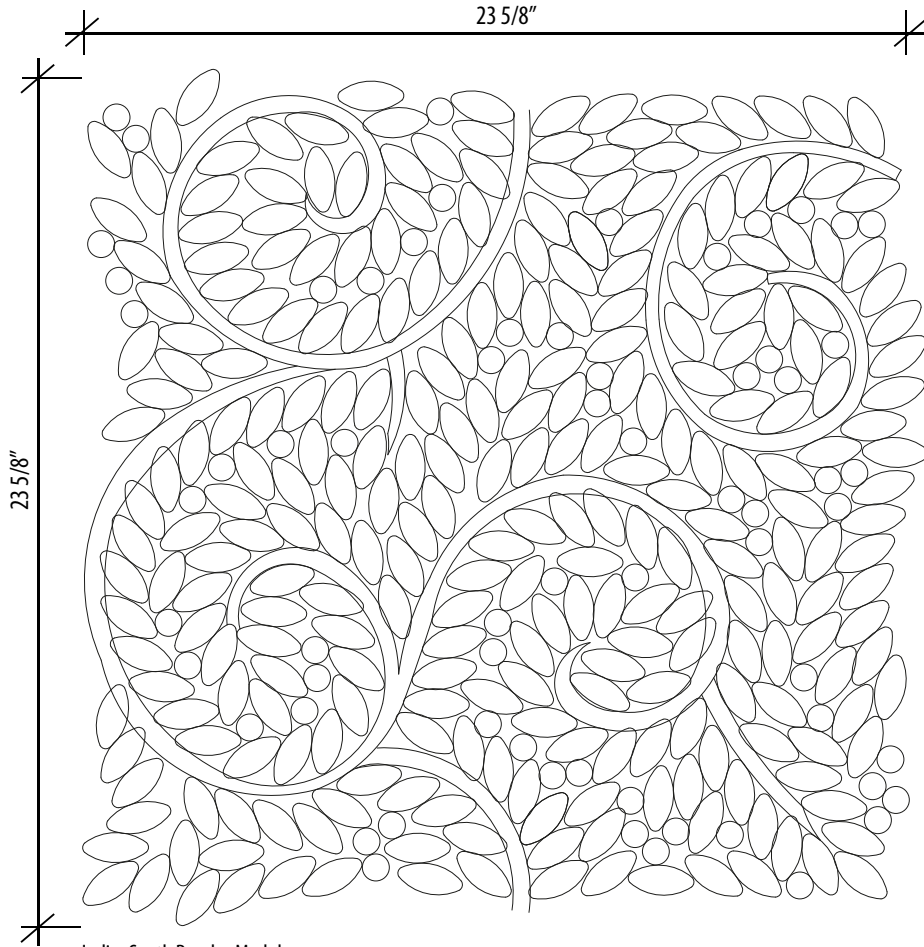

Indira South Beach - Module

 CUBES Tessera Size 7/8"x7/8"

 BARRELS Tessera Size Ø 6/8"

 DOMES Tessera Size 2"x7/8"

Sheet Size	SF per Piece	UOM	U/M per Carton	Pieces per Carton
23 5/8" x 23 5/8"	3,875	SF	3,875	1

Item can be purchased by full module



 **daltile**
IMAGINE WHAT'S POSSIBLE™

BLEND



Capri CL68**

Composition:

Iris 4	25%
Blue Angel	25%
Sapphire 3	25%
Periwinkle	25%

**Mesh-mounted

In dry environment can be used cementitious adhesive and grouting mortar.

The item can be used in wet or humid areas.

The adhesive and the grouting must be epoxy mortar.

All the technical specifications are contained in the Installation Manual on our website and at your disposal.

FIELD COLOR

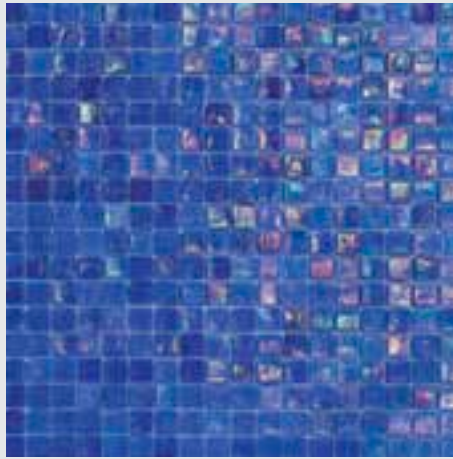

Iris 4 · Iridium

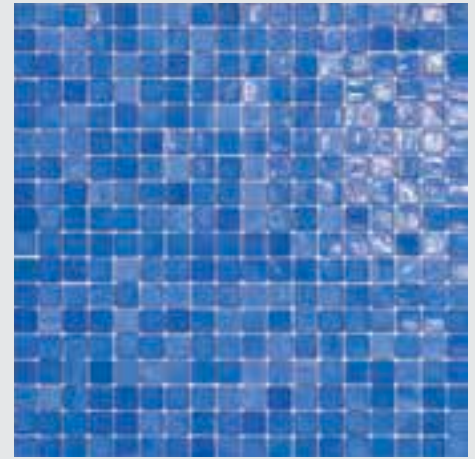

Blue Angel · Natural

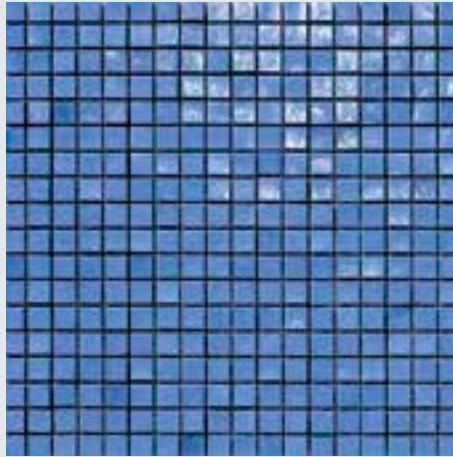

Sapphire 3 · Murano

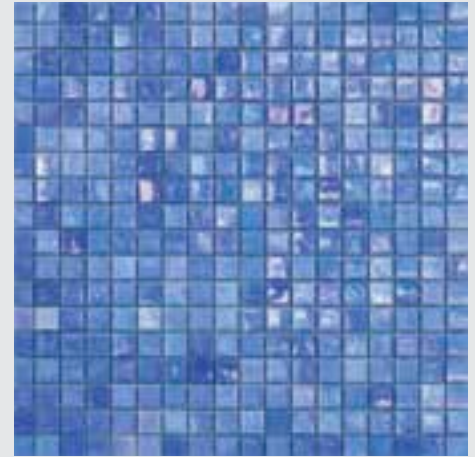

Periwinkle · Iridium

Chip size
0 5/8" x 0 5/8"

Sheet size
11 5/8" x 11 5/8"

Thickness
1/8"

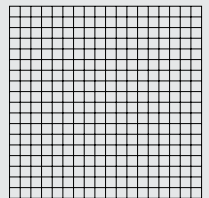

ITEM CAN BE PURCHASED BY THE SHEET

GLASS MOSAIC

CITY LIGHTS™

 **daltile**
IMAGINE WHAT'S POSSIBLE™

DUNE CAPRI



SICIS



GLASS MOSAIC
CITY LIGHTS™

 dalrile
IMAGINE WHAT'S POSSIBLE

Dune Capri*

CL49445156

KEY COLORS: 220 · 533 · 534 · 557 · 565 · 585

***Paper-mounted**

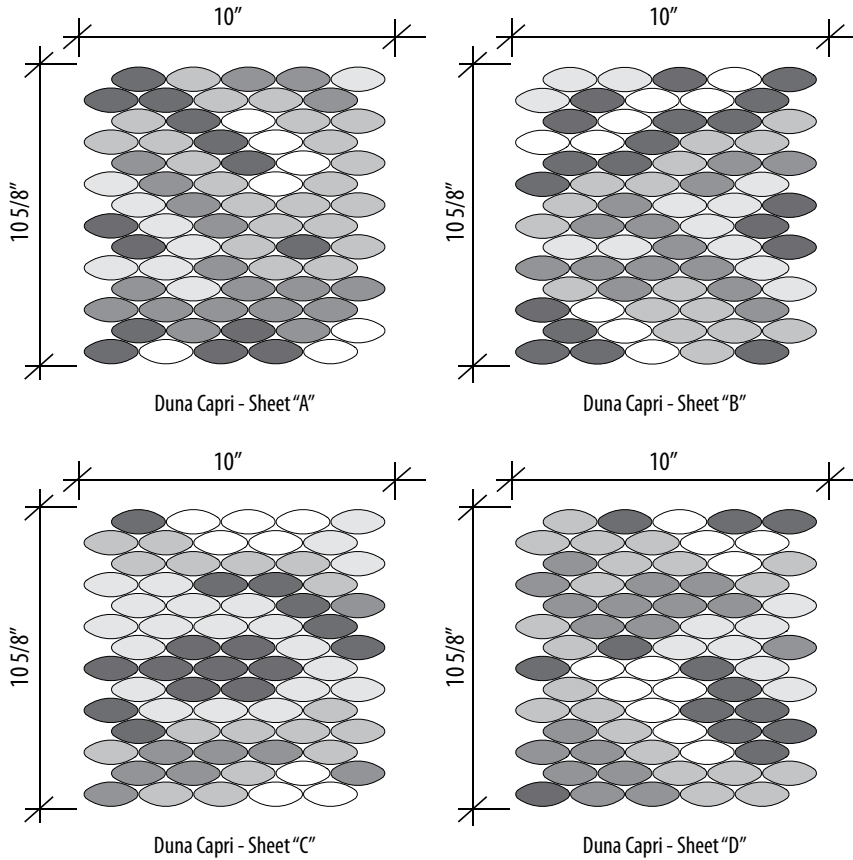

Sheet A	Sheet B
Sheet C	Sheet D

Full Module
Layout



DOMES Tessera Size 2"x7/8"

Sheet Size	SF per Module	UOM	U/M per Carton	Module per Carton
10" x 10 5/8"	2,928	SF	11,71	4

Item can be purchased by full module



DOMES 220



DOMES 557



DOMES 565



DOMES 585



DOMES 534



DOMES 533

The item can be used in wet or humid areas.
The adhesive and the grouting must be epoxy mortar.
All the technical specifications are contained in the Installation Manual on our website and at your disposal.

SICIS



 **daltile**
IMAGINE WHAT'S POSSIBLE™

BLEND



Honolulu CL72**

Composition:

Fern 3	20%
Fern 4	20%
Turquoise 3	20%
Aquamarine J	20%
Aquamarine 4	20%

****Mesh-mounted**

In dry environment can be used cementitious adhesive and grouting mortar.

The item can be used in wet or humid areas.

The adhesive and the grouting must be epoxy mortar.

All the technical specifications are contained in the Installation Manual on our website and at your disposal.

FIELD COLOR

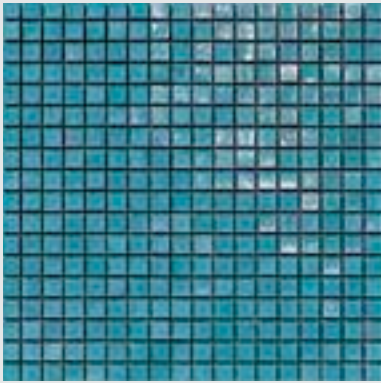

Turquoise 3 · Murano

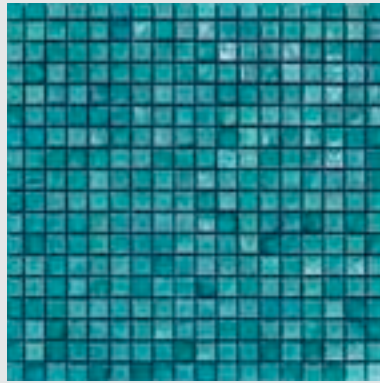

Aquamarine J · Murano

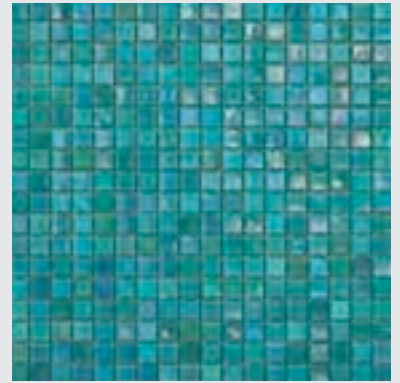

Fern 3 · Iridium

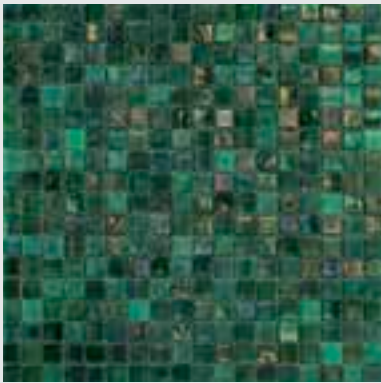

Fern 4 · Iridium

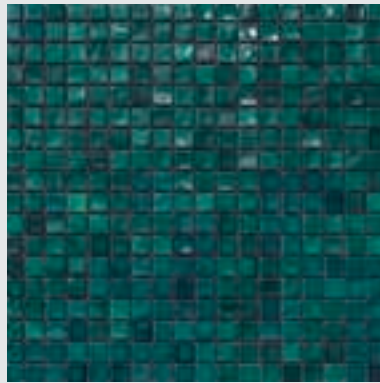

Aquamarine 4 · Murano

Chip size
0 5/8" x 0 5/8"

Sheet size
11 5/8" x 11 5/8"

Thickness
1/8"

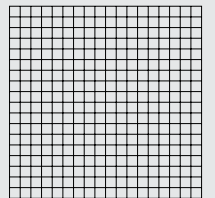

ITEM CAN BE PURCHASED BY THE SHEET

GLASS MOSAIC

CITY LIGHTS™

 **daltile**
IMAGINE WHAT'S POSSIBLE™

HONOLULU
CL72



SICIS

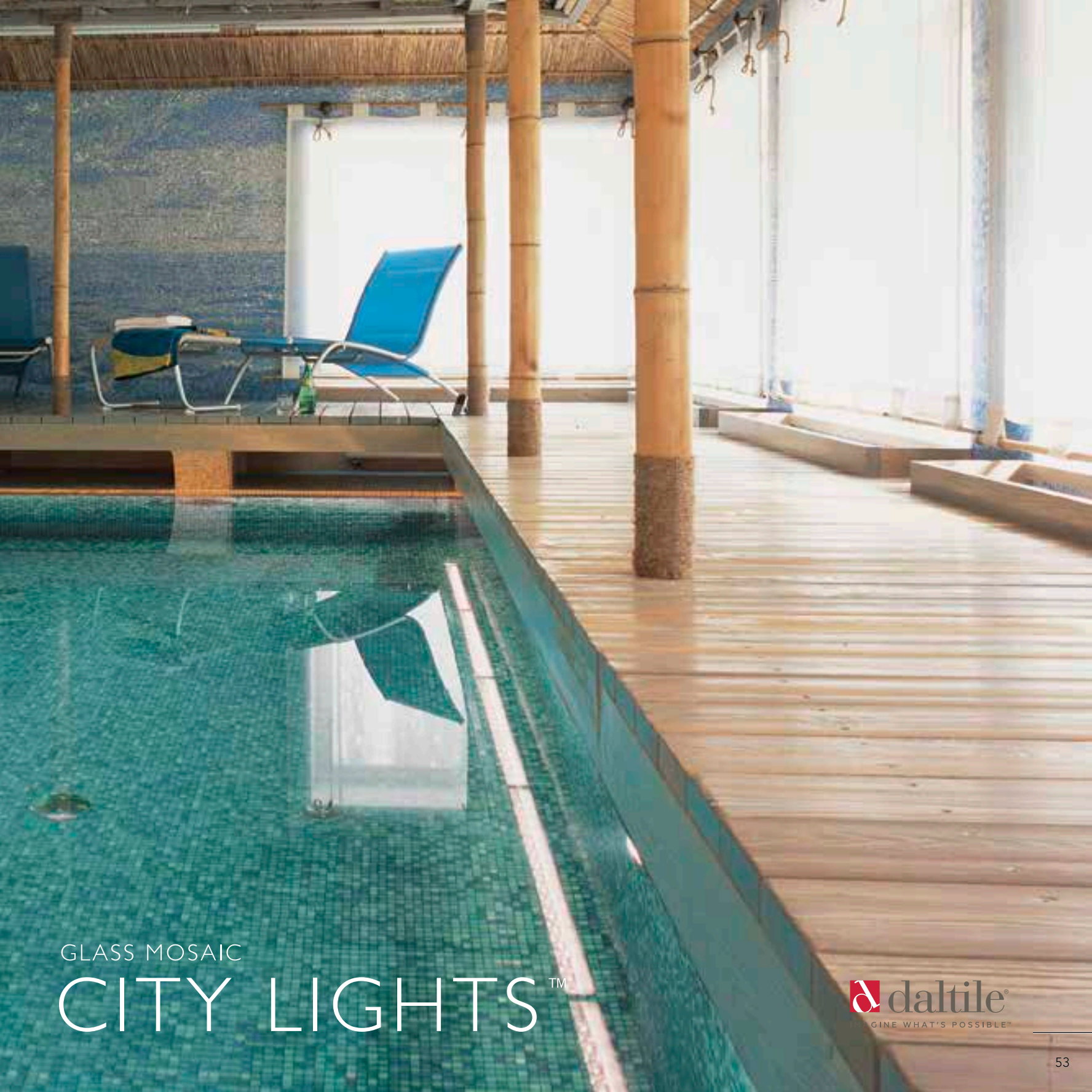

GLASS MOSAIC
CITY LIGHTS™

 daltile®
IMAGINE WHAT'S POSSIBLE™

BLEND

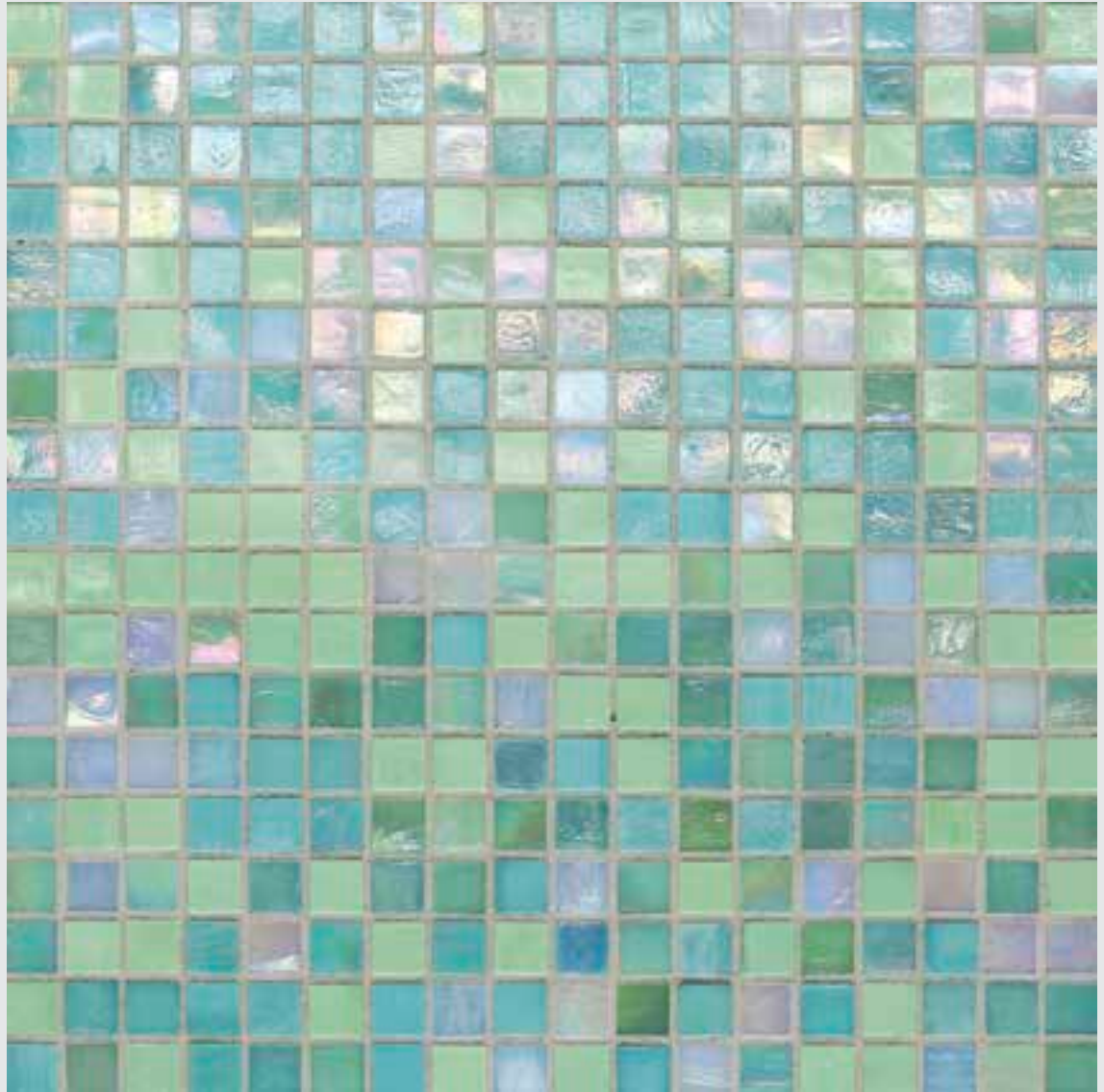

St. Thomas CL70**

Composition:

Iris 1	20%
Mint 2	20%
Emerald 2	20%
Fern 2	20%
Aquamarine 3	20%

****Mesh-mounted**

In dry environment can be used cementitious adhesive and grouting mortar.

The item can be used in wet or humid areas.

The adhesive and the grouting must be epoxy mortar.

All the technical specifications are contained in the Installation Manual on our website and at your disposal.

FIELD COLOR

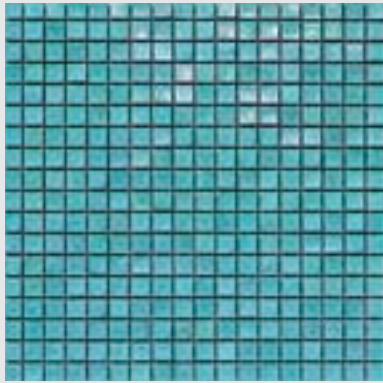

Aquamarine 3 · Murano



Fern 2 · Iridium



Iris 1 · Iridium



Mint 2 · Iridium

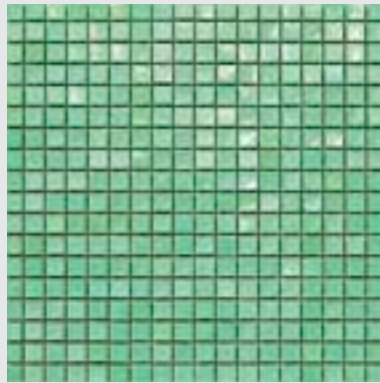

Emerald 2 · Murano

Chip size
0 5/8" x 0 5/8"

Sheet size
11 5/8" x 11 5/8"

Thickness
1/8"

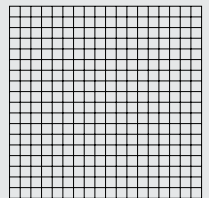

ITEM CAN BE PURCHASED BY THE SHEET

GLASS MOSAIC

CITY LIGHTS™

 **daltile**
IMAGINE WHAT'S POSSIBLE™



ST. THOMAS
CL70

SICIS



GLASS MOSAIC

CITY LIGHTS™

 **daltile**[®]
IMAGINE WHAT'S POSSIBLE™



BARRELS AURUM



BARRELS NG MILK
CHOCOLATE



PETITES FLEURS F13



DOMES 220



DOMES 221



DOMES 742

SICIS

The item can be used in wet or humid areas.
The adhesive and the grouting
must be epoxy mortar.
All the technical specifications are contained
in the Installation Manual
on our website and at your disposal.

Fluxus South Beach**

CL42445149

KEY COLORS:

220 · 221 · 742 · Aurum

F13 · NG Milk Chocolate

****Mesh-mounted**

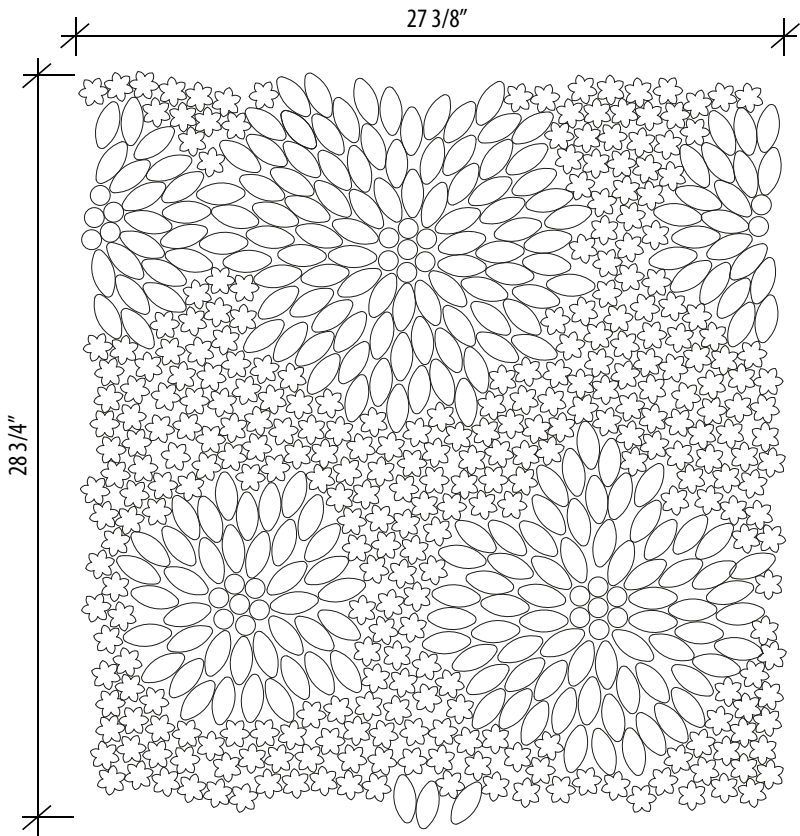

Fluxus South Beach - Module

 **BARRELS** Tessera Size $\varnothing 6/8"$

 **PETITES FLEURS** Tessera Size $\varnothing 1 1/4"$

 **DOMES** Tessera Size $2" \times 7/8"$

Sheet Size	SF per Piece	UOM	U/M per Carton	Pieces per Carton
27 3/8" x 28 3/4"	5,46	SF	5,46	1

Item can be purchased by the module



 IMAGINE WHAT'S POSSIBLE

Random Hollywood**

CL41445148

KEY COLORS:

510,5 R • 545 G • Aurum •
NG Birch • NG Sand

**Mesh-mounted

The item can be used in wet or humid areas.
The adhesive and the grouting must be epoxy mortar.
All the technical specifications are contained in the
Installation Manual on our website and at your disposal.

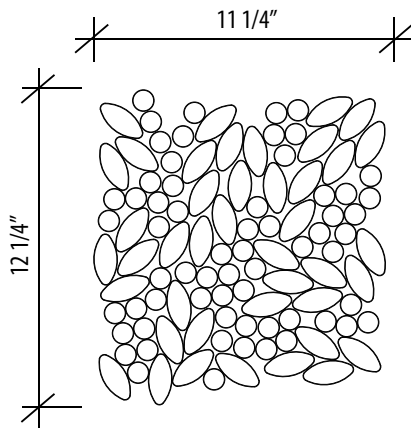

Random Hollywood - Sheet "A"

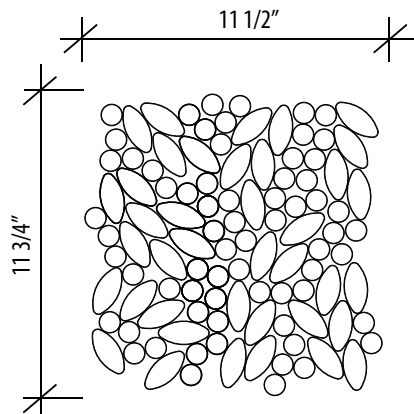

Random Hollywood - Sheet "B"

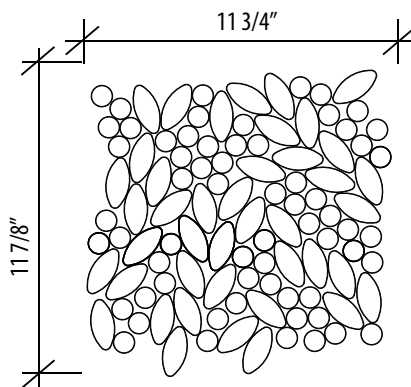

Random Hollywood - Sheet "C"

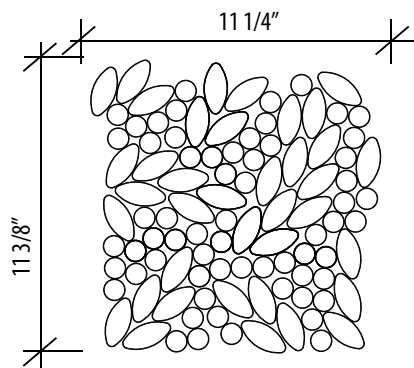

Random Hollywood - Sheet "D"



DOMES NG SAND



BARRELS 510,5 R



DOMES AURUM



BARRELS NG SAND



BARRELS AURUM



BARRELS NG BIRCH



BARRELS 545 G

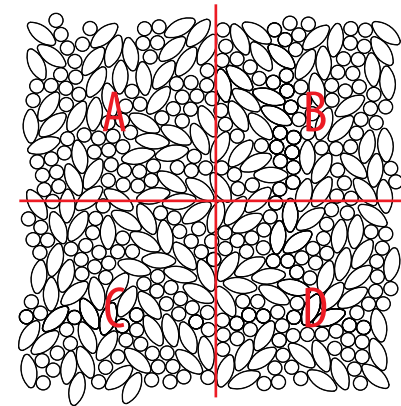

Random Hollywood
Full Module - Layout

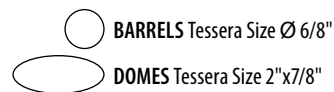

SICIS

Module Size	SF per Module	UOM	U/M per Carton	Module per Carton
22 1/2" x 22 3/4"	3,14	SF	12,56	4

Item can be purchased by full module



ed tempo A Tale of Light Through Time

Digital Photo 1

PHOTO

daltile

IMAGINE WHAT'S POSSIBLE

ovazione

BLEND



Hollywood CL64*

Composition:

Passion Flower	54%
Sand	10%
Aldebaran	09%
Marigold 2	27%

***Paper-mounted**

The item can be used in wet or humid areas.
The adhesive and the grouting must be epoxy mortar.
All the technical specifications are contained in the
Installation Manual on our website and at your disposal.

FIELD COLOR



Sicis Color: **Passion Flower** · Glimmer



Sicis Color: **Sand** · Natural



Sicis Color: **Aldebaran** · Colibrì



Sicis Color: **Marigold 2** · Iridium

Chip size

0 ⁵/₈" x 0 ⁵/₈"

Sheet size

11 ⁵/₈" x 11 ⁵/₈"

Thickness

1/8"

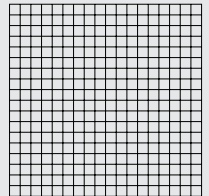

ITEM CAN BE PURCHASED BY THE SHEET

GLASS MOSAIC

CITY LIGHTS™

 **daltile**[®]
IMAGINE WHAT'S POSSIBLE™

Chantilly Paris*

CL84445164

KEY COLORS: 550 · NG Birch · NG Chestnut 1

***Paper-mounted**

The item can be used in wet or humid areas.
The adhesive and the grouting must be epoxy mortar.
All the technical specifications are contained in the
Installation Manual on our website and at your disposal.



BARRELS 550



BARRELS NG CHESTNUT 1



BARRELS NG BIRCH



BARRELS Tessera Size \varnothing 6/8"

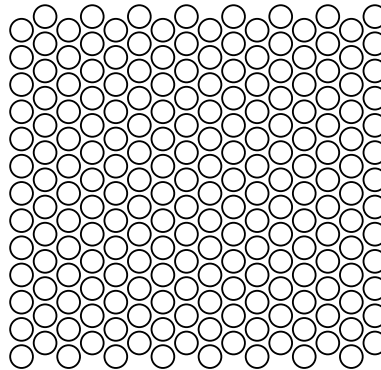

Sheet size

11^{5/8"} x 10^{7/8"}

Thickness

1/4"

Box

16 sheets

ITEM CAN BE PURCHASED BY THE SHEET

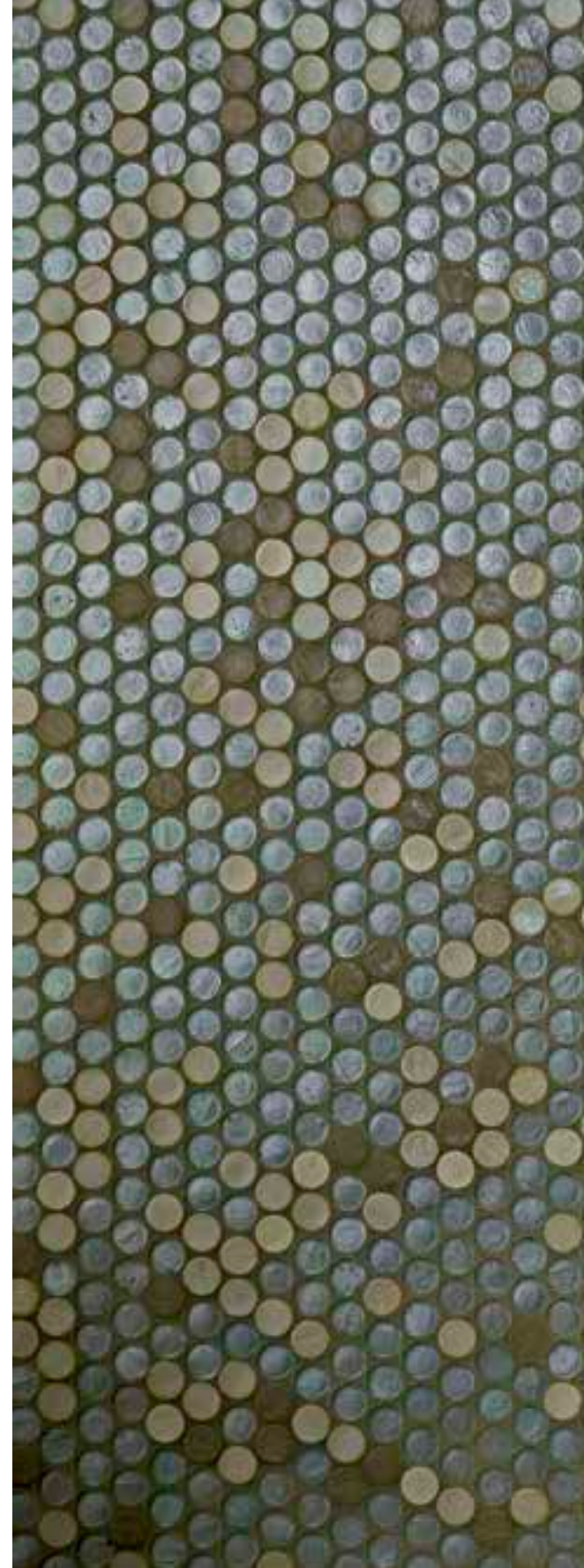





SICIS



Tarantula Las Vegas*

CL59445161

KEY COLORS: 502 · 544 · 546 · 746 · NG INDACO · NG Titanium 2

*Paper-mounted

The item can be used in wet or humid areas.
The adhesive and the grouting must be epoxy mortar.
All the technical specifications are contained in the
Installation Manual on our website and at your disposal.

 BARRELS Tessera Size Ø 6/8"

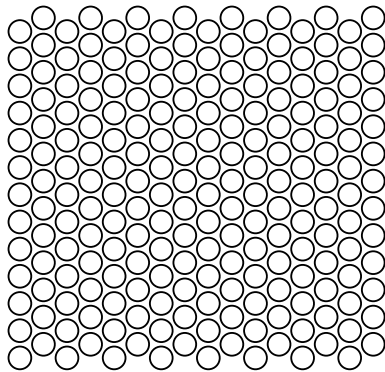

Sheet size

11^{5/8}" x 10^{7/8}"

Thickness

1/4"

Box

16 sheets

ITEM CAN BE PURCHASED BY THE SHEET



BARRELS 502



BARRELS 544



BARRELS 546



BARRELS 746



BARRELS NG INDACO



BARRELS NG TITANIUM 2

BLEND



Las Vegas CL69**

Composition:

Petunia 4	56%
Horizon	10%
Black	28%
Swami	03%
Astrid	03%

****Mesh-mounted**

The item can be used in wet or humid areas.
The adhesive and the grouting must be epoxy mortar.
All the technical specifications are contained in the
Installation Manual on our website and at your disposal.

SICIS

FIELD COLOR

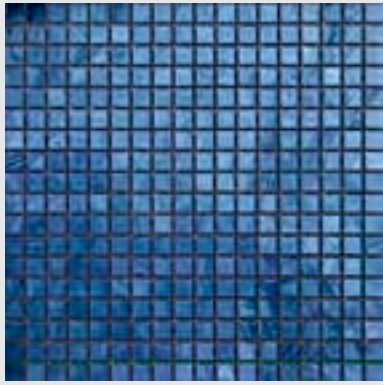

Astrid · Colibrì

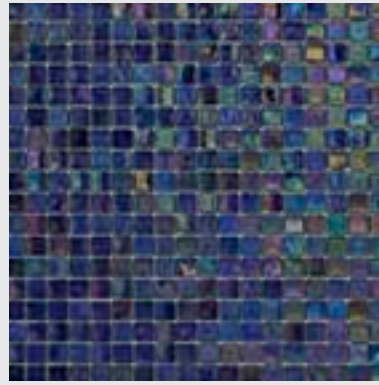

Petunia 4 · Iridium

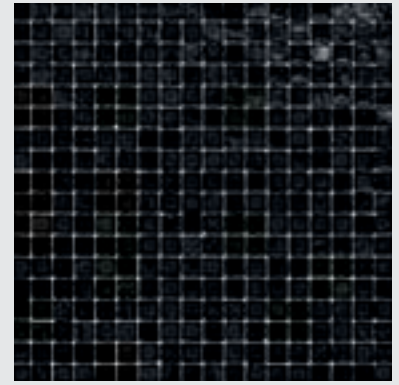

Black · Murano

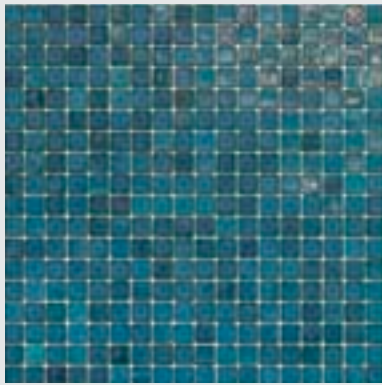

Horizon · Natural

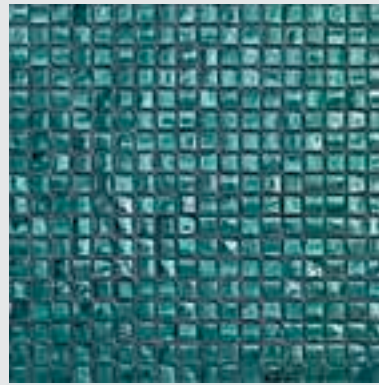

Swami · Colibrì

Chip size
0 5/8" x 0 5/8"

Sheet size
11 5/8" x 11 5/8"

Thickness
1/8"

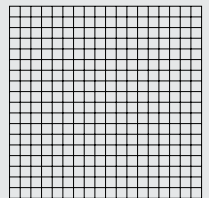

ITEM CAN BE PURCHASED BY THE SHEET

GLASS MOSAIC

CITY LIGHTS™

 **daltile**
IMAGINE WHAT'S POSSIBLE™

LAS VEGAS CL69

SICIS



GLASS MOSAIC

CITY LIGHTS™

 **daltile**
IMAGINE WHAT'S POSSIBLE™

BLENDSS



Tokyo CL62*

Composition:

Azalea 4	20%
Blackberry	20%
Beachplum	20%
Amethyst 4	20%
Mirtillo	20%

***Paper-mounted**

In dry environment can be used cementitious adhesive and grouting mortar.

The item can be used in wet or humid areas.

The adhesive and the grouting must be epoxy mortar.

All the technical specifications are contained in the Installation Manual on our website and at your disposal.

FIELD COLOR

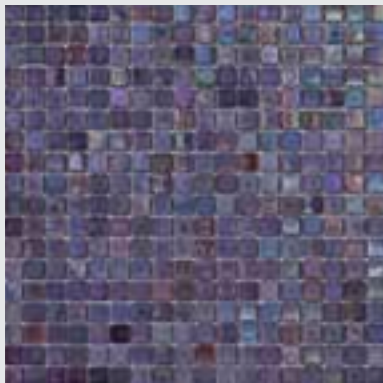

Azalea 4 · Iridium



Amethyst 4 · Murano

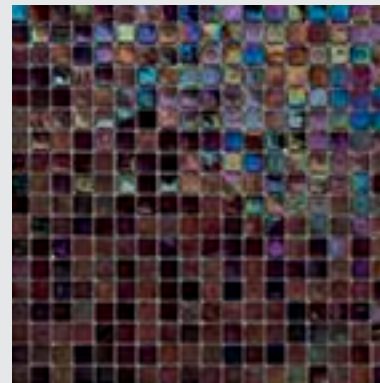

Mirtillo · Glimmer

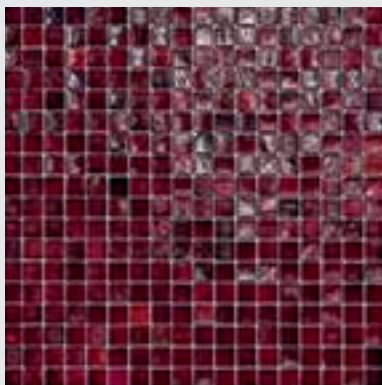

Blackberry · WaterGlass



Beachplum · WaterGlass

Chip size
0 5/8" x 0 5/8"

Sheet size
11 5/8" x 11 5/8"

Thickness
1/8"

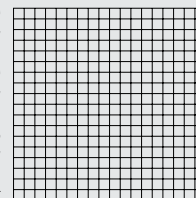

ITEM CAN BE PURCHASED BY THE SHEET

GLASS MOSAIC

CITY LIGHTS™

 **daltile**
IMAGINE WHAT'S POSSIBLE™

BLEND



Fiji CL75*

Composition:

Papaya	30%
Kiwi	25%
Pear	25%
Spring	20%

***Paper-mounted**

In dry environment can be used cementitious adhesive and grouting mortar.

The item can be used in wet or humid areas.

The adhesive and the grouting must be epoxy mortar.

All the technical specifications are contained in the Installation Manual on our website and at your disposal.

SICIS

FIELD COLOR

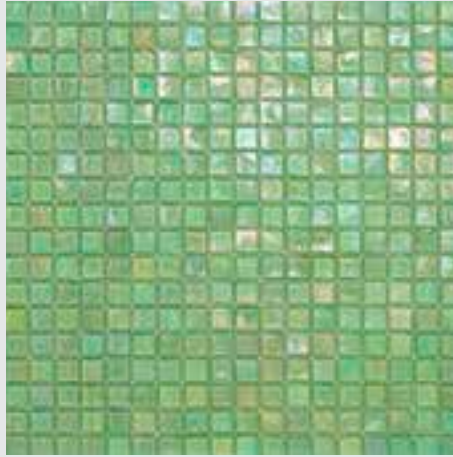

Papaya · Glimmer

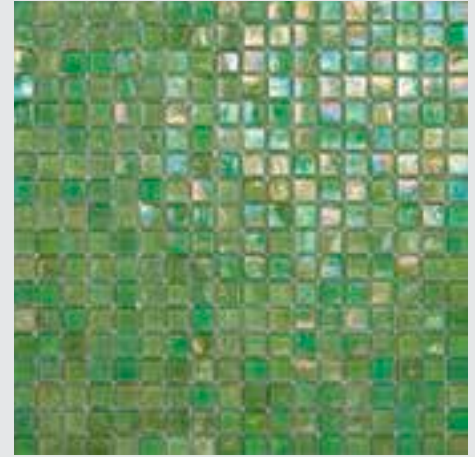

Kiwi · Glimmer

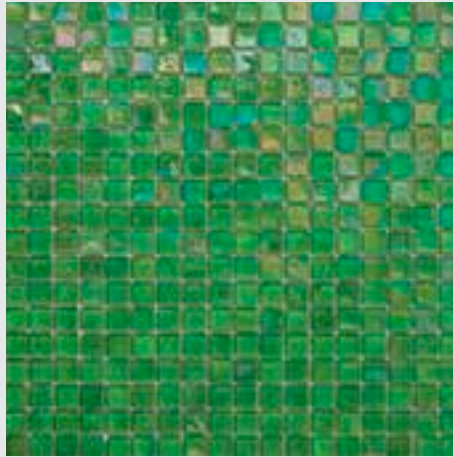

Pear · Glimmer

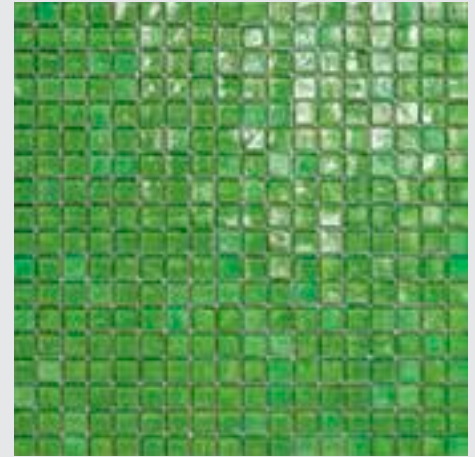

Spring · WaterGlass

Chip size
0 5/8" x 0 5/8"

Sheet size
11 5/8" x 11 5/8"

Thickness
1/8"

ITEM CAN BE PURCHASED BY THE SHEET

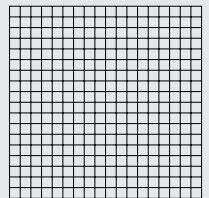

GLASS MOSAIC

CITY LIGHTS™

 **daltile**
IMAGINE WHAT'S POSSIBLE™

BLENDS



Rio CL73**

Composition:

Horizon	50%
Mud	30%
Earth	20%

****Mesh-mounted**

In dry environment can be used cementitious adhesive and grouting mortar.
The item can be used in wet or humid areas.
The adhesive and the grouting must be epoxy mortar.
All the technical specifications are contained in the Installation Manual on our website and at your disposal.

FIELD COLOR

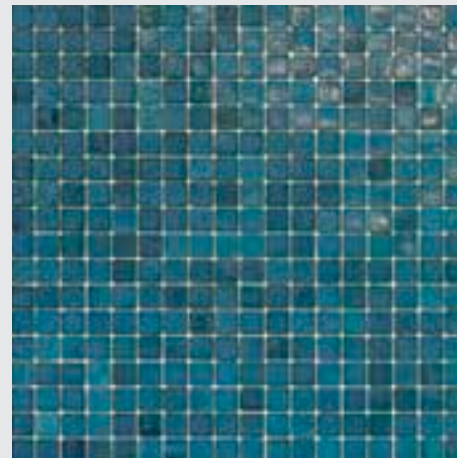

Horizon · Natural

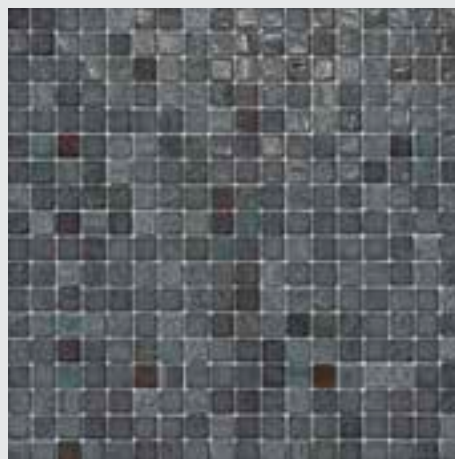

Mud · Natural

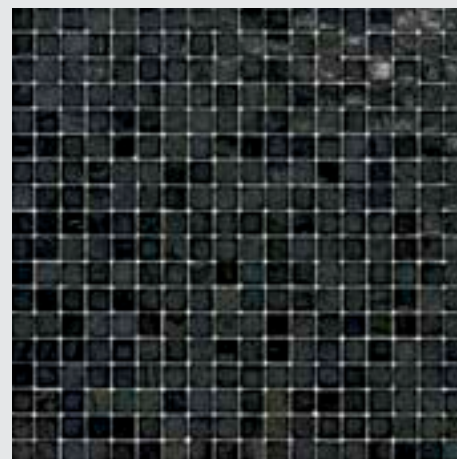

Earth · Natural

Chip size
0 5/8" x 0 5/8"

Sheet size
11 5/8" x 11 5/8"

Thickness
1/8"

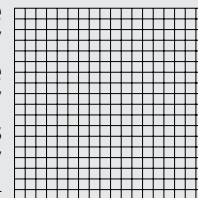

ITEM CAN BE PURCHASED BY THE SHEET

GLASS MOSAIC

CITY LIGHTS™

 **daltile**
IMAGINE WHAT'S POSSIBLE™

TECHNICAL INFORMATION



COMMERCIAL USAGE

APPLICATION	INTERIOR			EXTERIOR	
	Residential	Light Commercial	Commercial	Residential	Commercial
Floors/Patios	✓	✓*			
Walls/Backsplashes	✓	✓	✓	✓	✓
Countertops	✓	✓	✓	✓	✓
Pool Decking					
Pool Lining	✓	✓	✓	✓	✓

Suitable in freezing and non-freezing climates when proper installation methods are followed. Not for use on shower floors.

*Office building restroom floors and hotel baths only

RESIDENTIAL USAGE

APPLICATION				
Floors	Walls	Countertops	Exterior Patios	Exterior Pool Decks
F	W	C		

TEST RESULTS

	ASTM#	Result
Water Absorption	C373	< 0.5%
Breaking Strength	C648	> 250 lbs
Scratch Hardness	MOHS	8.0
Chemical Resistance	C650	Resistant
Dynamic C.O.F.	A137.1	Wet: ≥ 0.42
Abrasion Resistance	ASTM-C1027	4

INSTALLATION

Thickness	Grout Joint Recommendation	Shade Variation
1/8"	1/16" Approximately	 Random (V4)

NOTES

Paper-face and mesh-mounted installation instructions are included in carton.

Strong random shading enhances the beauty of this product. To achieve optimal results, tile should be selected from multiple cartons and shading arrangement planned prior to installation.

Since there are variations in all fired ceramic products, the tile and trim supplied for your particular installation may not match these samples. Final color selection should be made from actual tiles and trim and not from tile and trim samples or color reproductions. Manufactured in accordance with ANSI A137.1 standards.

Water, oil, grease etc. create slippery conditions. Floor applications with exposure to these conditions require extra caution in product selection. Not for use on ramps.





For more information about Daltile products and services, visit our website at DAL TILE.COM.
©2015 DAL-TILE CORPORATION | 7834 C.F. HAWN FREEWAY | DALLAS, TX 75217 | 800.933.TILE